

AT HOMIE

infinite atmospheres



537
catàlogo



www.ismoble.com
/// TIENDA ONLINE //////////////////////////////////////



ROMANTIC ROOM

9

.....

EVERY DAY

53

.....

URBAN TIME

105

.....

TECHNICAL SECTION

153

.....

AT HOME

infinite atmospheres



ROMANTIC

Di cosa sono fatti i sogni? In ROMANTIC ROOM diamo corpo ai sogni dei più romantici, selezionando e unendo materiali preziosi: legno massello, tessuti pregiati e pomelli in pura ceramica.

Il legno lavorato artigianalmente è avvolto da finiture lisce in tinte pastello nuove e attualissime, abbinate alla lavorazione shabby, vintage e soave, interpretata in quattro varianti colore.

Tra i tessuti risalta per preziosità il lino, ricercato e fine in ogni sua applicazione. Ma è la lavorazione sapiente di ogni tessuto che crea

l'effetto a sorpresa, come nella grande novità della collezione:

i letti imbottiti con magnifiche testiere coronate da rouche.

Armadi, cassettiere e scrivanie sono impreziosite dalle due stampe su disegni originali, create in esclusiva per Callesella: la floreale, che ridesta antiche memorie, e la geometrica, che richiama il mondo fashion. Entrambe esaltano l'atmosfera romantica grazie a una gamma cromatica tenue ma ricca di carattere.

A siglare la creatività della collezione, gli splendidi pomelli in ceramica.

Decorati con una fantasia inesauribile di texture diverse, da coordinare oppure da mixare adattandosi a ogni gusto.

Per un'interpretazione unica e personale dell'idea di romanticismo.

What dreams are made of? In ROMANTIC ROOM we give substance to the dreams of the most romantic ones, choosing and combining precious materials: solid wood, refined fabrics and pure ceramic knobs.

The handcrafted wood is covered by new and trendy smooth finishes in pastel colours combined with a vintage and delicate shabby finish in four different colours.

The precious linen stands out among the fabrics, always refined. But it is the skillful workmanship of each fabric which creates the surprise effect, as in the great innovation of the collection: the upholstered beds with amazing headboards surrounded by ruches.

Wardrobes, dressers and desks are enhanced by two prints on original drawings created exclusively for Callesella: the floral one, which evokes ancient times, and the geometrical one, which refers to the fashion world. Both of them highlight the romantic atmosphere thanks to a range of pale colours full of character.

Wonderful ceramic knobs mark the creativity of this collection. They are decorated with a boundless imagination of different patterns, to be combined or mixed according to each taste.

For a personal and unique interpretation of romanticism.

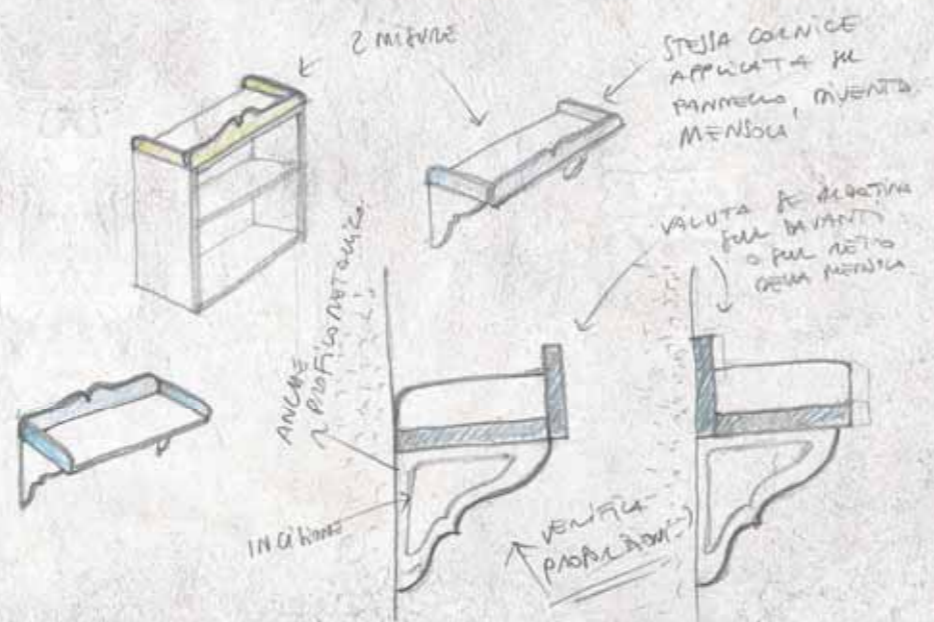

ROMANTIC ROOM

INSPIRATION SECTION ONE

Il nostro desiderio è farvi sognare. Il nostro mestiere creare ambienti nei quali è spontaneo farlo. Per questo abbiamo ideato composizioni capaci di ispirarvi anche nei piccoli gesti quotidiani, mentre creano un'atmosfera unica che colorerà ogni risveglio. Il fascino di poetici scorci parigini. Il tepore di una villa di campagna. O semplicemente la casa che avete sempre desiderato... Lavoriamo la materia più nobile, per metterla a disposizione della vostra fantasia. Forme, tessuti, colori e volumi: tutto nella collezione Romantic Room si accorda armoniosamente per disegnare un luogo nel quale niente sembra impossibile. Sta alla forza del legno rendere reale l'immaginato. Alle soluzioni funzionali rispondere alle vostre esigenze. Romantic Room è un sogno, ma un sogno a occhi aperti.

Our wish is making you dream. Our job is creating unique spaces where dreaming is natural. For this reason we designed compositions able to inspire you in the simple daily gestures while creating a unique atmosphere which will colour every awakening. The charm of poetic Parisian glimpses. The coziness of a country house. Or simply the house you have always wanted.... We craft the highest quality material to make it available to your imagination. Shapes, fabrics, colours and volumes: in Romantic Room collection everything perfectly harmonizes designing a place where nothing seems impossible. It is up to the wood to bring imagination into reality. It is up to the functional solutions to meet your needs. Romantic Room is a dream, or rather a daydream.



POKOW ATLAS GLORIE
SEDIA TESSUTO (AURUM)
POLTRONA
EXCLUSIVE 900 28ISS
Cl. 900
(CON BOVINE WOLF)
LEDO

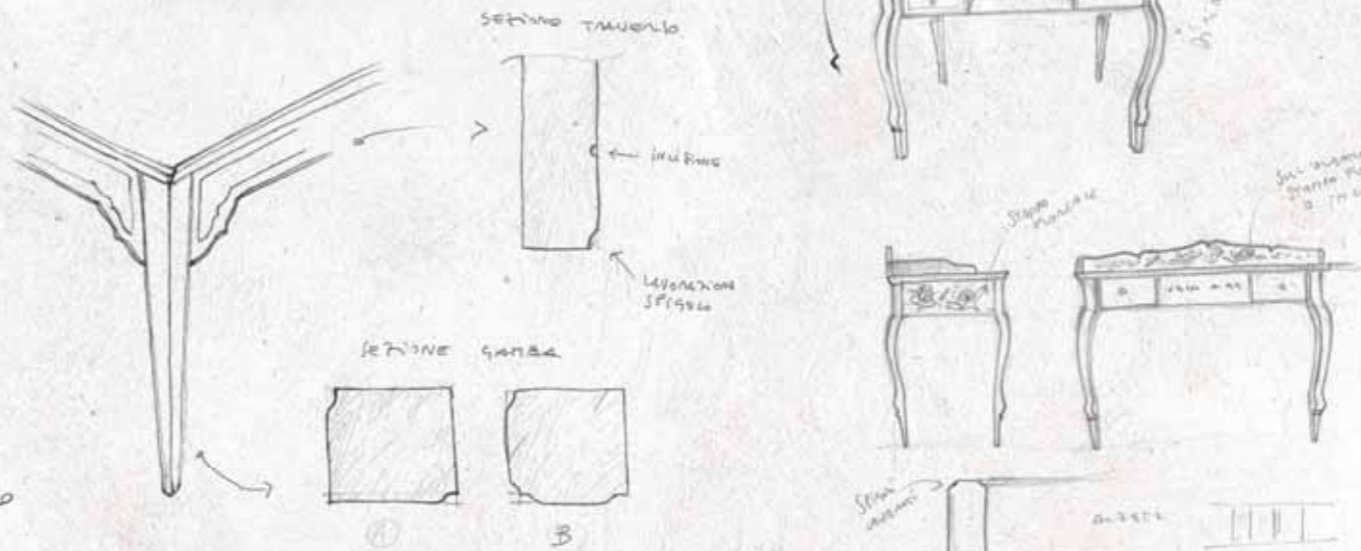
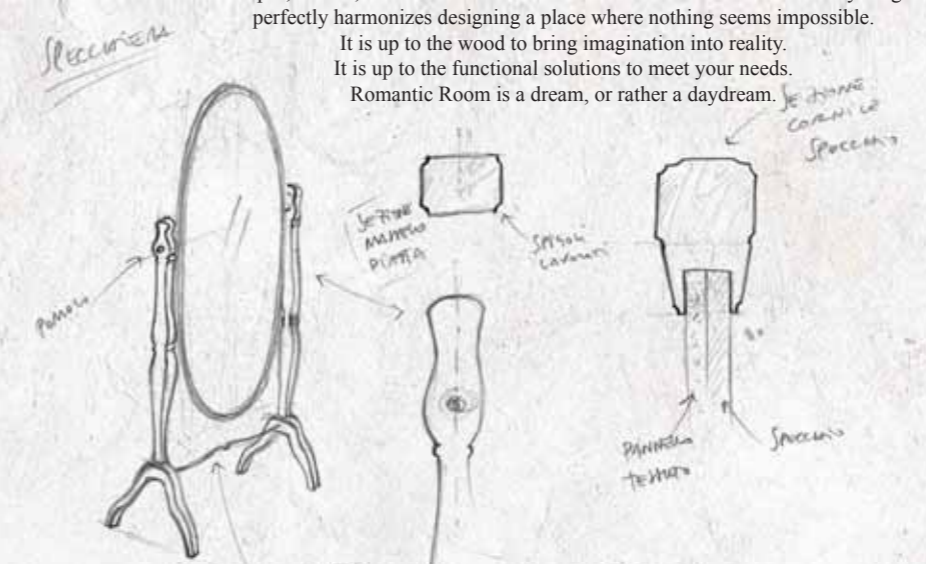
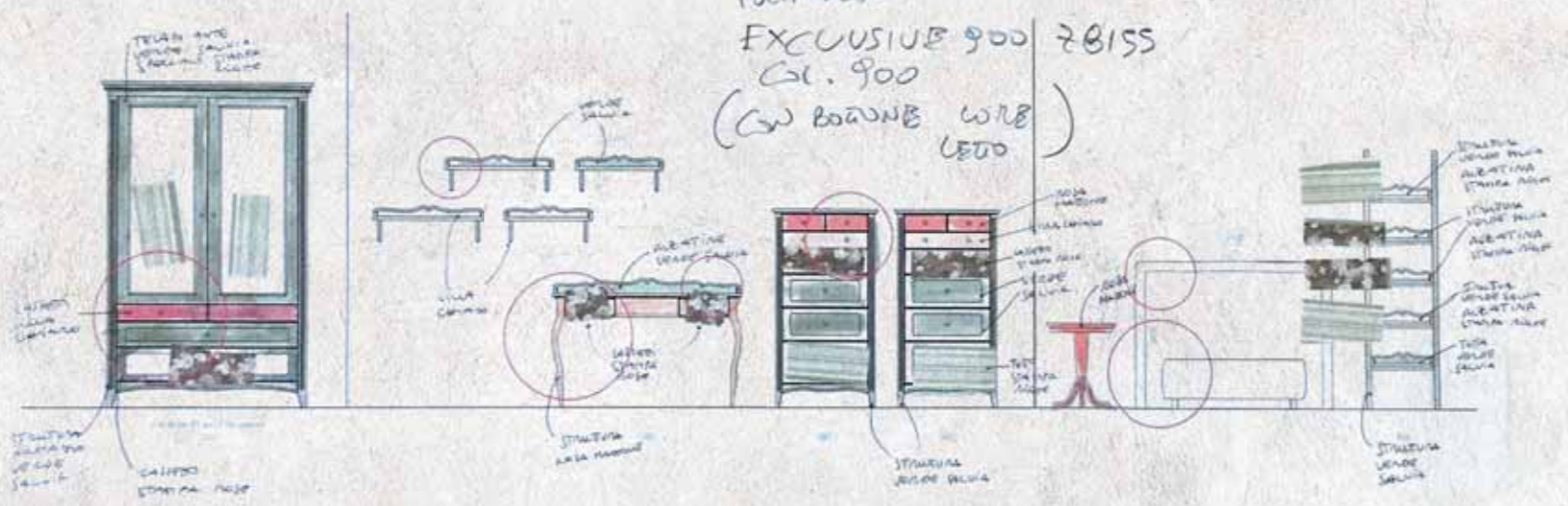

COLORE SHABBY (1)
+ LACCATO



BED ROOM

ROMANTIC SECTION ONE



La collezione Romantic Room esprime tutto l'amore per i dettagli dell'artigiano falegname.
Un gusto romanticamente senza tempo che si colora di nuove ispirazioni.
Così i classici tornano a essere una sorprendente novità.

Romantic Room collection expresses all the love for details of the carpenter craftsman.
A romantically timeless taste coloured with new inspirations.
Therefore, the classics become a surprising novelty again.







In queste composizioni per camerette tutto è romanticamente shabby e coordinato. Le stampe floreali e lineari firmano i cassetti dello scrittoio, la scaletta-libreria e i frontali del settimanale. Il tocco di classe sono gli originali pomelli in ceramica, da scegliere e abbinare nei colori e nei disegni.

In these compositions for children's rooms everything is romantically shabby and coordinated. Floral and geometrical prints mark the desk's drawers, the ladder bookcase and the fronts of seven-drawer chest. A touch of class is given by the unique ceramic knobs to choose from and match in colours and patterns.



CALLESELLA
Wood furniture since 1896







CALLESSELLA
Wood furniture since 1896







Con il loro gioco di dimensioni e colori e le linee raffinate dei fregi,
i cubi creano una cornice preziosa per ogni oggetto.
La schiena può essere personalizzata e coordinata con
le stampe inserite nei cassetti dello scrittoio.

With a play of sizes and colours and the refined shapes of friezes,
shelves create a precious frame for everything.
The back panel can be customized and matched with the prints of the desk's drawers.





La verniciatura shabby chic nei toni del rosa, rigorosamente eseguita a mano e mai uguale a se stessa, rivela il mestiere dell'artigiano e rende unico ogni pezzo. Questo è il sapore autentico del mobile artigianale.

Shabby chic painting in shades of pink, strictly handmade and never the same, shows the craftsmanship and makes each piece unique. This is the authentic taste of the handcrafted furniture.



handmade shades of pink





Shabby Atmosphere

La specchiera ballerina, inclinabile, è proposta in 18 colorazioni diverse per essere perfettamente abbinabile a qualsiasi combinazione Romantic Room (e non solo).

Standing cheval floor mirror with tilt action is available in 18 different colours to perfectly match with any Romantic Room combination (and not only).



L'alternanza dinamica di volumi e colori nei cubi sospesi esalta il romanticissimo letto in legno, caratterizzato dalla finitura shabby chic bianca e dalla testiera in lino imbottita e impreziosita da rouche.

The dynamic combination of the suspended cubes in volumes and colours enhances the romantic wooden bed, which is characterised by the white shabby chic finish and the upholstered linen headboard decorated with ruches.





CALLESELLA
Wood furniture since 1896





aesthetics and comfort

L'elegante divano letto in finitura fango nasconde, dietro il frontale lavorato, un ampio e pratico cassettone o un secondo letto per ospitare gli amici del cuore.

The refined sofa bed in mud finish hides, behind the decorated front, a wide and practical storage drawer or a second bed where to accommodate the best friends.





CALLESELLA
Wood furniture since 1896

**“i matrimoniali”
“double rooms”**

Confortevoli, ricercati, seducenti:
in prezioso tessuto o in vero legno,
i letti matrimoniali Romantic Room
sono immaginati per essere protagonisti
in ogni composizione.

Comfortable, refined, seductive:
in precious fabric or in solid wood,
Romantic Room double beds are conceived to
be protagonists in every composition.





timeless style



Lo spaziosissimo armadio è personalizzabile grazie alla doppia opzione di anta: Provenza o Dogata. I vivaci giochi cromatici tra i pomelli in ceramica e le stampe floreali dei cassetti creano un contrasto originale con la sobrietà della chiave classica.

The very spacious wardrobe can be customized thanks to the double door option: Provenza or Slatted. The bright chromatic effects between the ceramic knobs and the floral prints of the drawers create an original contrast with the sobriety of the classic key.





Sono i dettagli a creare l'atmosfera perfetta.
Il pomello a forma di Rosa è una vera rarità che dona
una classe indimenticabile al comò.
Disponibile in diverse lavorazioni,
è perfetto abbinato alla lavorazione shabby chic
in color carta da zucchero.

Details create the perfect atmosphere.
Rosa knob is a true rarity that gives an unforgettable
style to the dresser. Available in different treatments,
it is perfect combined with shabby chic treatment in
Carta da Zucchero colour.



Luxury Details





Imponente ma armonioso, l'armadio componibile è arricchito dal fianco con mostrina. Anche i colori più classici e puri diventano incredibilmente attuali grazie alle finiture eseguite con maestria.

Majestic but harmonious, the modular wardrobe is embellished by the decorated side panel. Even the most classic and pure colours become incredibly modern thanks to the craftsmanship of the finishes.



EVERY DAY

Voi affrontate impegni e sfide quotidiane.

Noi disegniamo luoghi accoglienti e confortevoli dove potrete ritrovare il vostro spazio ogni giorno.

Circondati dalla vitalità del legno, valorizzata da tinte ecologiche ad acqua.

Su una dominante di tinte fredde - grigi, azzurri, verdi - si accendono i toni caldi del rosa, del bruno e del rosso.

Colori delicati e naturali che sfumano sulla matericità del legno massello spazzolato, talcato e invecchiato.

Sulle classicissime ante a telaio si inseriscono innovativi pomelli in ferro e in cuoio. A contrasto con la forza dei materiali ferrosi e lignei, abbiamo inserito tessuti morbidi e vellutati che accarezzano i soffici volumi di sedie, poltroncine e testiere imbottite.

È la ricerca di questi accostamenti inediti a rendere possibile un carattere rustico ma elegante, il classico che affiora senza togliere modernità all'insieme.

Questa è la cifra stilistica della collezione Every Day.

You deal with daily tasks and challenges.

We design cozy and comfortable places where you can find your own space every day surrounded by the wood's vitality, enhanced by ecological water-based paintings.

Beyond a leading range of cold colours - greys, blues, greens - warm colours like pink, brown and red light up.

Natural and soft colours blend into the solid brushed wood, in talced or distressed finish.

Very classic framed doors include original knobs in iron and leather.

In contrast with the strenght of iron and wooden materials we combined soft and smooth fabrics which brush the soft volumes of chairs, armchairs and upholstered headboards.

The research of these original combinations makes it possibile a rustic but refined character, the classic wich emerges without deducting modernity to the ensemble.

This is Every Day's signature style.

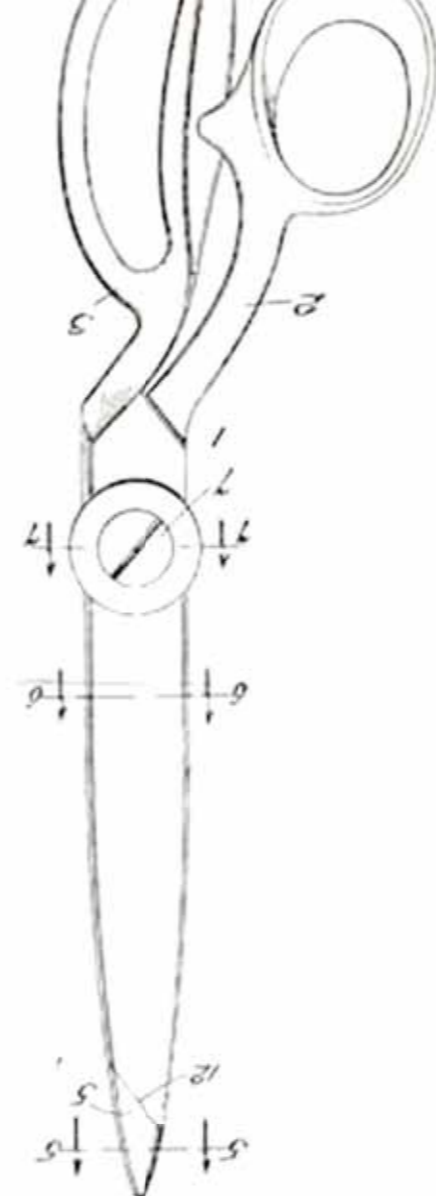
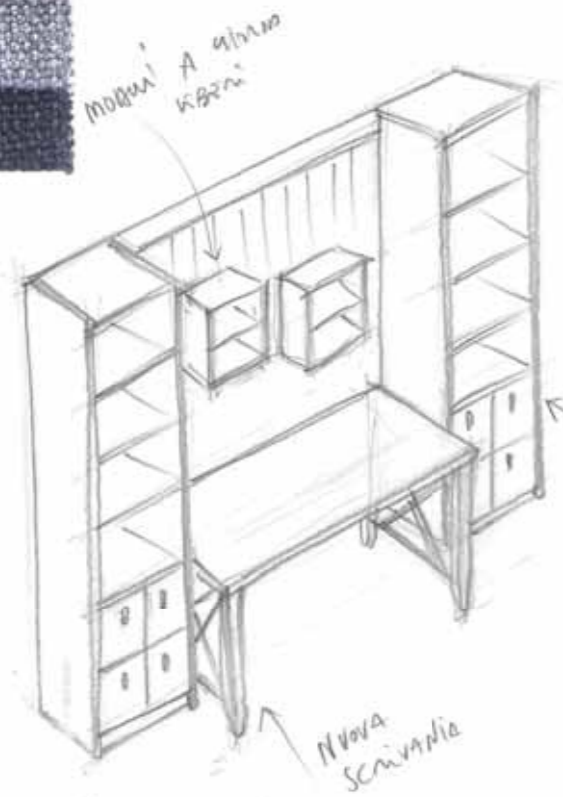

INSPIRATION EVERY DAY

« SECTION TWO »

Tanti accostamenti cromatici delicati colorano il comfort degli arredi Every Day. Abbinamenti classici come bianco e nero, legno e metallo, ritornano in nuove interpretazioni. Raffinato o minimal? È sufficiente un dettaglio inedito a svoltare il gusto di un ambiente.

Many soft colour combinations paint the comfort of Every Day furniture. Classic combinations as black and white, wood and metal, lead to new interpretations. Refined or minimal? An original detail can simply change the room's taste.

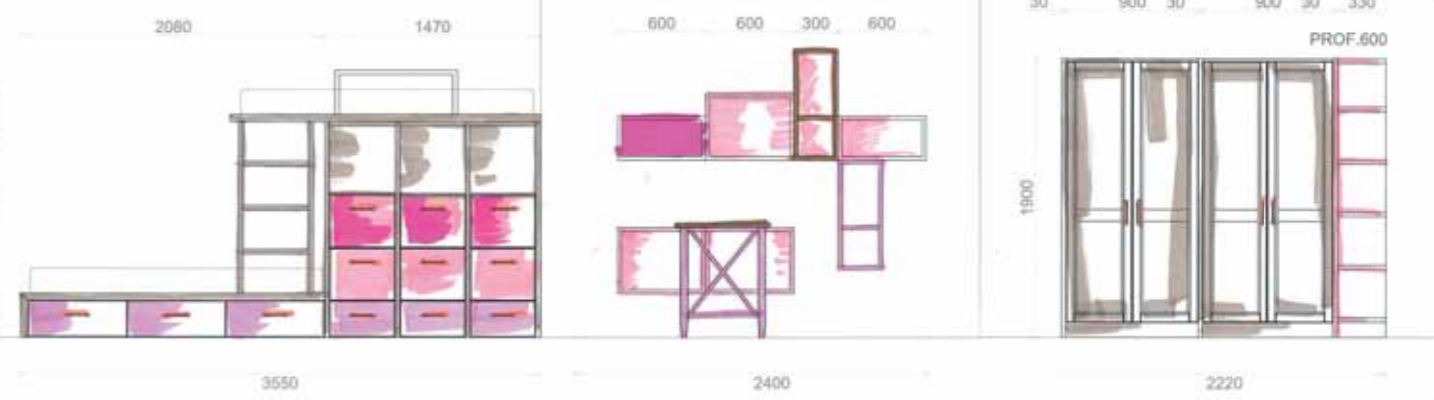
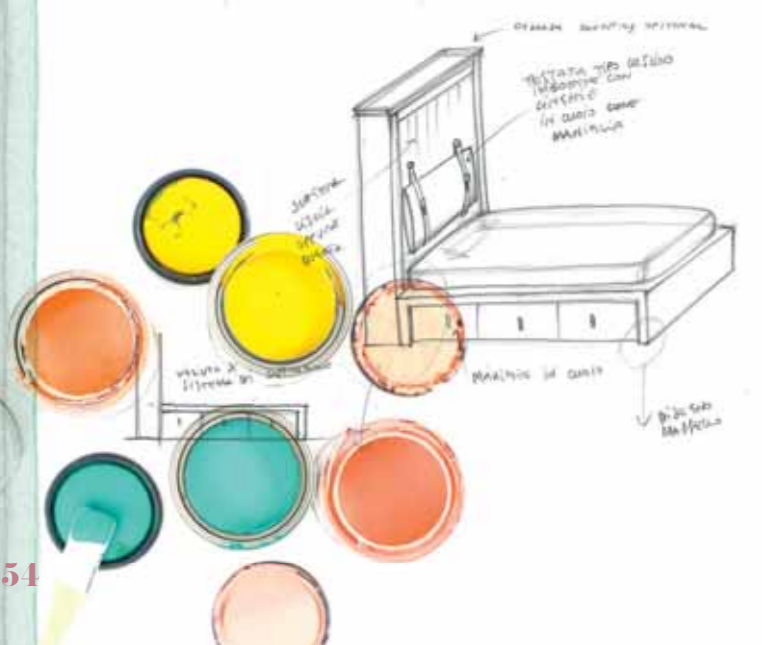
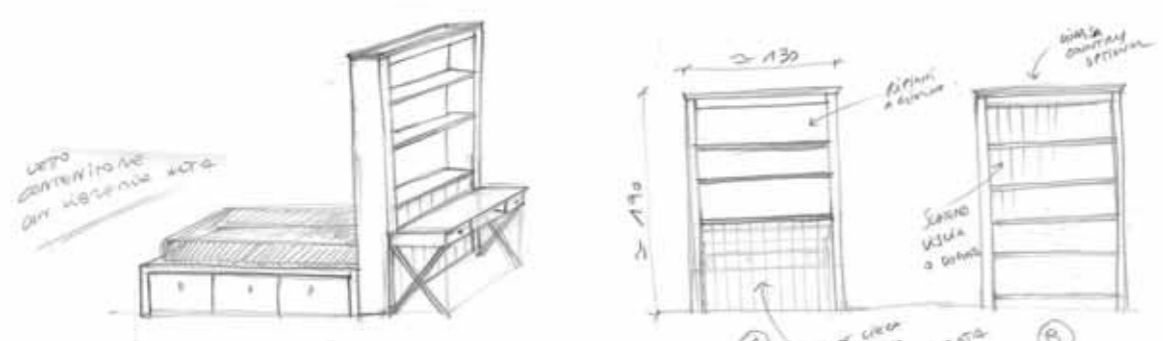

tono scuro
spallato
rose cilian
rosa
rose nature
elle d'oro
legno spallato
+ scuro (cappuccino)

EVERY DAY
BED ROOM
« « SECTION TWO » »

Il sapore autentico del legno spazzolato è messo in risalto dai colori naturali e dalle linee pulite del design.
La tradizione artigianale guida la realizzazione di mobili senza tempo.
Nuovi classici che valorizzano tutte le qualità del legno.

The authentic taste of the brushed wood is enhanced by natural colours and clear design.
The craft tradition lead the production of timeless furniture.
New classics give value to each wood's quality.







PURE MATERIALS

From Wood To Leather

Con la collezione Every Day il sapore autentico del legno è rinvigorito dai colori laccati nelle nuove finiture tabacco, salvia e petrolio. In tutte le varianti spicca il dettaglio del pomello in vero cuoio.

With Every Day collection the lacquered colours in the new Tabacco, Salvia and Petrolio finishes invigorate the authentic taste of wood. The genuine leather knob stands out in every combination.



Every Day dona nuova vita al settimanale, valorizzando ogni cassetto con le sfumature di colore tono su tono e con l'inaspettata maniglia realizzata in cuoio.

Every Day gives new life to the seven-drawer chest enhancing each drawer with tone-on-tone shades and with the surprising leather handle.





Insolita e dinamica, questa composizione mette il letto al centro della stanza e sfrutta la libreria per dividere la zona notte dalla zona studio.

A ribadire il carattere unico del mobile, il grande cuscino con cinghie in cuoio e il giro letto dotato di cassetti apribili su entrambi i lati.

Unusual and dynamic, this composition imagines the bed in the middle of the room and uses the bookcase to divide the sleeping area from the study area. The huge cushion with leather straps and the bed frame equipped with drawers on both sides, mark the unique style of this furniture.

Anche negli spazi meno ampi,
Every Day offre la soluzione per arredare con
gusto e senza rinunciare a nulla:
libreria, letto,
spazi contenitivi trovano la loro dimensione ideale.

Even in the smallest spaces,
Every Day gives the solution for furnishing with taste,
without giving up anything: bookcase, bed,
storage spaces find their perfect place.

Composizione 08



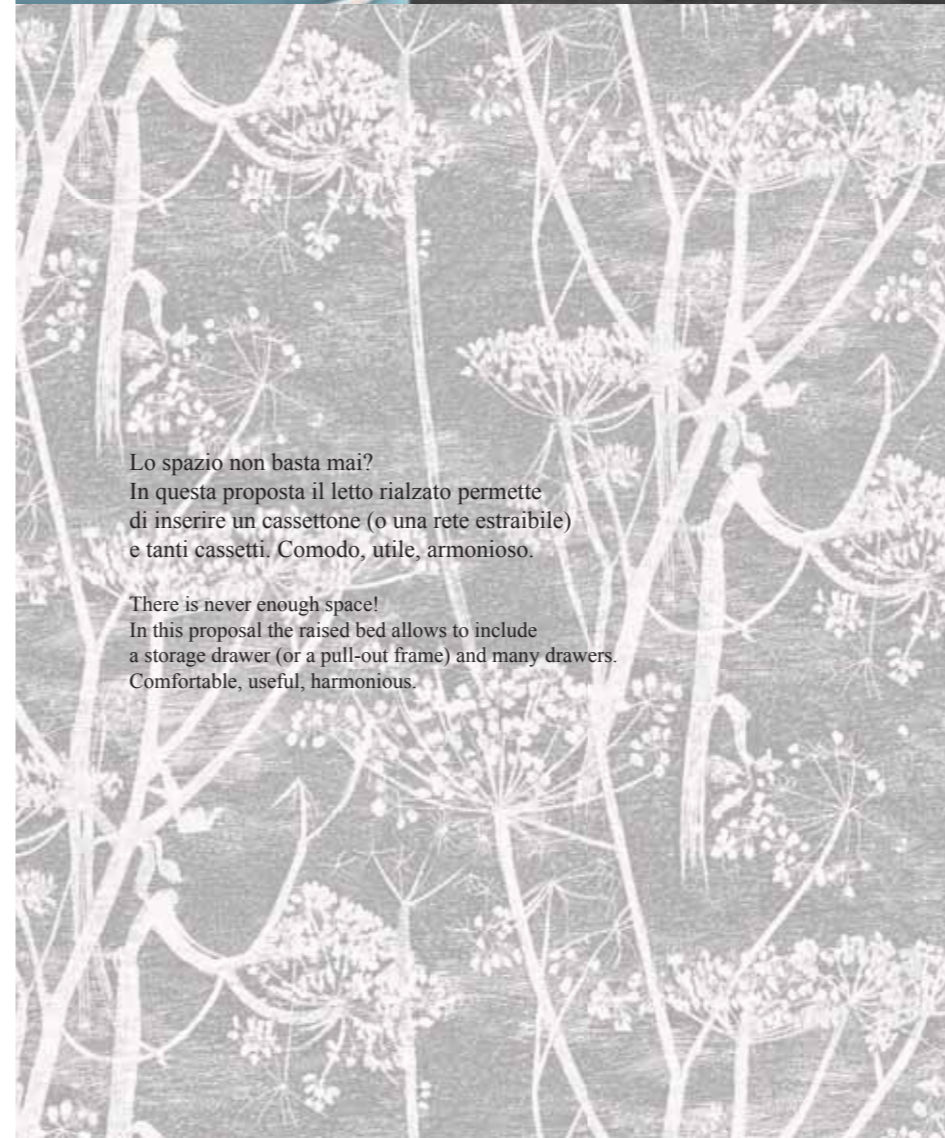

Lo spazio non basta mai?
 In questa proposta il letto rialzato permette
 di inserire un cassettone (o una rete estraibile)
 e tanti cassetti. Comodo, utile, armonioso.

There is never enough space!
 In this proposal the raised bed allows to include
 a storage drawer (or a pull-out frame)
 and many drawers. Comfortable, useful, harmonious.







STYLISH AND PERSONAL

La boiserie orizzontale con doghe di diverse dimensioni crea movimento e consente di personalizzare la stanza. Ma a prendersi la scena è l'originale testiera a cuscino con cinghie in cuoio e tessuto trapuntato... come non innamorarsene?

The horizontal boiserie with slats of different sizes creates movement and allows you to customize your room. However, the protagonist is the original cushion headboard with leather straps and quilted fabric... how not to fall in love?



SMART CONNECTIONS

Il morbido cuscino imbottito esalta la testiera del letto Stella mentre lo scrittoio si fonde con le basi-comodino: in questa camera tutto è armonicamente e funzionalmente connesso.

The soft padded cushion enhances Stella bed's headboard, while the desk blends with the nightstand-bases: in this room everything is harmonically and functionally connected.



Nella cabina armadio potrete organizzare tutto su misura per voi, grazie a luci, ripiani e cassettiere inseribili a piacere. Ordinata, efficiente, elegante.

For those who are not familiar with the communicative value of surfaces it is often difficult to pair materials and colours. We have prepared some examples of pairings aimed at making every room in







INTO A WOODEN WORLD

Ogni oggetto trova il suo posto grazie all'organizzazione ottimale degli spazi, ai capienti elementi a ponte e ai raffinati cubotti a giorno.
Quando tutto è in ordine, risalta ancora di più il gusto senza tempo del vero legno.

Everything finds its place thanks to the optimal organization of the spaces, the capacious overhead units and the refined open cubic elements. When everything is organised, the timeless taste of real wood stands out even more.







COLOURFUL TOUCHES

Spaziosi e pratici, i cassetti, i cestoni e i cassettoni si colorano nelle tinte confetto, pesca e magenta.
Per accendere di allegria la cameretta e rendere un gioco anche mettere in ordine.

Spacious and practical, drawers, deep drawers and storage drawers are coloured in shades of Confetto,
Pesca and Magenta. To light up the bedroom making a game also tidy up.



La parete della camera diventa una tela da dipingere grazie agli elementi a giorno di diversi colori, da abbinare e mixare, e alle schiene personalizzabili con stampe. Spazio alla fantasia!

The bedroom's wall become a canvas to be painted thanks to the open units of different colours, to combine and mix, and the back panels that can be customized with prints. Leave space for imagination!







CALLESELLA
Wood furniture since 1896

A photograph of a bedroom interior. In the foreground, a bed is covered with a dark, textured duvet and a patterned pillow. In the background, a window with white frames is visible, and a modern lamp with a white shade is positioned on a bedside table. The lighting is soft and natural, coming from the window.

CALLESELLA
Wood furniture since 1896

“I MATRIMONIALI” “DOUBLE ROOMS”

È la camera da letto, tra tutte le stanze di una casa, quella in cui più cerchiamo comfort e relax. Grazie a mobili che con il loro design pulito ci accompagnano verso riposi tranquilli e risvegli solari.

Among all the house's rooms the bedroom is where we look for more comfort and relax, thanks to furniture with clear design which bring us to peaceful sleeps and cheerful awakenings.



GET YOUR STYLE

Legno o cuoio?

Il materiale delle maniglie non è scontato e rivela il gusto di chi lo ha scelto. Per questo vi offriamo la possibilità di esprimere il vostro stile anche nei dettagli.

Wood or leather?

The material of the handles is not obvious and reveals the taste of those who chose it. This is why we give you the chance to express your style even in the details.







Composizione 14

Molto più di uno splendido letto:
con il suo giro-letto contenitore e l'inaspettata testiera a cuscino,
questo modello trasforma la camera in un luogo per sognare.

Much more than a beautiful bed:
with its storage bed frame and the unexpected cushion headboard,
this model changes your bedroom into a dreaming place.

URBAN TIME

Ogni dettaglio è in armonia in questa collezione assolutamente contemporanea ed essenziale, caratterizzata dalle ante dritte. I colori della terra conferiscono la loro energia a ogni mobile Urban Time. Tinte purissime e assolutamente naturali, che sono appena velate da vernici ad acqua ecologiche e rispettose dell'ambiente, fonte preziosa da rispettare. Alle linee semplici e rigorose fanno da contrappunto i volumi compatti e tondi dei pomelli. I telai in metallo visibili e l'uso di tessuti da rivestimento consistenti e caldi donano un twist nuovo e originale alla collezione. È un metodo di arredare lo spazio completamente nuovo.

Each detail is harmonized in this absolutely contemporary and essential collection characterised by straight doors. Earthy colours give their energy to Urban Time furniture. Extra pure and completely natural paintings are covered with a veil of ecological water-based varnishes which respect the precious environment. Simple and strictly shapes contrast with the solid and rounded volumes of the knobs. Visible metal frames and compact warm covering fabrics give a new original twist to the collection. A completely new way to furnish the room.



ECOLOGIC

URBAN TIME

INSPIRATION

"SECTION THREE"

Design minimalista, pulizia formale, autenticità e amore per la natura sono i valori di una sensibilità sempre più diffusa.

Una tendenza che diventa qualcosa di più: uno stile di vita che guarda all'essenza delle cose e cerca più equilibrio tra sé e l'ambiente.

Nella collezione Urban Time abbiamo interpretato tutto questo e lo abbiamo trasformato in progettazione d'interni.

Minimal design, clean lines, authenticity and love for nature are the values of an increasingly widespread awareness.

A trend which becomes something more: a lifestyle founded on the essence of things looking for a better balance with the environment.

In Urban Time collection we personalised this idea converting it into a design project.



TAPCA

219-219
ELETTRICO
COLANNO

= LETTO SERRICE
IN MATELLO

PIÙ ALTE
CON UN MARCHIOLO
LA TESTATA
INCLINATA
IN PUNTO/CALORE

CONVINCERE
L'OPERA
IN MATELLO

PASSATE
QUALI
CON
SINGOLA

FAVORE
CANTO/PAVANO
CON LA
E BORDO

DETTA
CON SINGOLA
E BORDO

INCLINATA
CON
MATELLO



BED ROOM

URBAN TIME

"SECTION THREE"

PRIVATE ATMOSPHERES

Per la camera da letto abbiamo creato composizioni ariose e confortevoli, scegliendo una palette di colori puri e naturali per infondere serenità.

Uno studio accurato che ha prodotto un linguaggio nuovo, ma sempre legato alle nostre radici artigiane.

For the bedroom we have created spacious and comfortable compositions, choosing a palette of pure and natural colours to instill serenity.

A careful study that produced a new language, forever linked to our artisan roots.







Crea una nuova atmosfera nella zona notte!
 La testiera imbottita diventa utile oltre che esteticamente perfetta,
 grazie alle tasche nelle quali riporre un libro,
 un tablet o un pensiero prima di addormentarsi.

Create a new atmosphere in the sleeping area!
 The upholstered headboard becomes useful as well as aesthetically perfect,
 thanks to the pockets where to store a book,
 a tablet or a thought before falling asleep.



Per chi ama riflettere, la specchiera Xenon
 è disponibile in tre differenti finiture per
 rispecchiare stili personali e di arredo diversi.

For those who love to reflect, Xenon wall mirror is
 available in three different finishes to display different
 personal styles and furniture.



Piccoli tocchi di colore nei pomelli donano vitalità alla razionalità dell'armadio Fly: ricco di cassetti, mensole e vani contenitivi modulabili per soddisfare ogni necessità.

Small touches of colour in the knobs give vitality to the rationality of Fly wardrobe: full of drawers, shelves and modular storage compartments to satisfy every need.







L'essenziale è visibile agli occhi e
diventa elemento decorativo:
i fianchi in legno massello tengono
sospesi comodino e settimanale.
Puro e semplice stile.

The essential is visible to the eyes and
becomes a decorative element:
the solid wooden sides hold a suspended
nightstand and a seven-drawer chest.
Pure and simple style.





La bellezza è esaltata dalla qualità.
L'anta Easy è un triplo strato dello spessore di 26 mm:
toccare con mano il valore del legno è un vero piacere.

Beauty is enhanced by quality.
Easy door is a three-layer wood with a thickness of 26 mm:
touching the value of the wood is a real pleasure.





Ante e cassetti si dispongono e si combinano in modo simmetrico o asimmetrico. I pomelli cambiano forme e dimensioni assecondando le preferenze personali. Gli armadi Argon sono tutt'altro che "standard".

Doors and drawers are arranged and combined symmetrically or asymmetrically. Knobs change shapes and sizes according to personal preferences. Argon wardrobes are anything but "standard".





Disponibile nei raffinati colori bianco e grigio, la struttura in metallo della libreria è pronta a sostenere tutte le mensole e i pensili che servono per soddisfare le esigenze di chi la userà.

Available in refined white and grey colours, the metal structure of the bookcase is ready to support all the necessary shelves and wall units according to the needs of those who will use it.



Piano della scrivania e comodino diventano iconici grazie a variazioni di design che aggiungono funzionalità e uno stile unico.

Desk's top and nightstand become iconic thanks to design variations that add functionality and a unique style.



La matericità del legno è evidente in questo armadio dalle linee pulite. Sono i particolari a rivelare la sua modernità: pomelli colorati a contrasto e di dimensioni diverse, abbinabili a piacere, e l'appendiabiti esterno, essenziale nel design e incredibilmente utile.

Wood's materiality is clear in this wardrobe with clean lines. The details reveal its modernity: contrasting coloured knobs of different sizes, to be matched as you like, and the external clothes hanger with an essential design and incredibly useful.



Il design del presente rivisita le forme del passato:
nello scrittoio Uranio il legno del piano con alzatina è
abbinato al ferro della struttura a incrocio.

The modern design revisits the shapes of the past:
the top's wood with a backslash of Uranio desk is combined
with the iron of the cross-over structure.



La testiera Cromo è stata immaginata per accostare tonalità diverse in ogni suo pannello. Variazioni di stile delicate e personalizzabili.

Cromo headboard has been designed to match different colours in each panel. Delicate and customizable style variations.





Cornice perfetta per studi e progetti:
la libreria Fly è componibile,
attrezzabile e modulabile per soddisfare
preferenze ed esigenze di ognuno.

Perfect frame for studying and designing:
Fly bookcase is modular, it can be equipped and
adapted to suit everyone's tastes and needs.





CALLESELLA
Wood furniture since 1896

“I MATRIMONIALI” “DOUBLE ROOMS”

Ispirate dallo stile nordico,
le composizioni URBAN TIME
rispondono al desiderio di pulizia, serenità,
leggerezza. Privilegiando praticità e un'estetica pura.
Non abbiamo paura di cambiare le regole.
Per questo abbiamo reinterpretato elementi
dall'assoluto valore estetico rendendoli improvvisamente
multifunzionali. Come la testiera portadocumenti.

Northern style inspired compositions,
URBAN TIME reflects the desire of elegance, calm and lightness.
Practicality and pure aesthetics are favoured.
We are not afraid to change the rules.
For this reason we have reinterpreted completely aesthetic
elements making them suddenly multifunctional.
As for the document-holder headboard.





Le preziose e inimitabili venature naturali del legno spazzolato sono valorizzate al massimo dall'uso di rispettose vernici ecologiche.

The precious and unique natural veins of brushed wood are enhanced by the use of respectful ecological paints.



La testata Azoto accompagna i vostri sogni e custodisce morbidamente buoni propositi e pensieri della sera, grazie alle originali tasche confezionate nel tessuto.

Azoto headboard embraces your dreams and softly preserves good intentions and thoughts of the evening, thanks to the original pockets integrated in the fabric.



CALLESELLA
Wood furniture since 1896



"GLI ARMADI" "WARDROBES"

Strutture nascoste vanno oltre la loro funzione di sostegno e rivelano la loro presenza, sagomando profili nuovissimi e sorprendenti. L'alternanza dei colori tra ante e maniglie permette di creare un gioco cromatico sulle pure note del legno naturale. Ogni composizione è possibile, anche su misura.

Concealed structures go beyond their support function and show their existence, shaping new and amazing profiles. Colours variation between doors and handles create a chromatic contrast with the pure natural wood. All compositions are possible, even made to measure.



L'anta Tetris trasforma l'armadio in un quadro da personalizzare.
 Quale modo migliore per esprimere il vostro gusto e
 rendere unica la vostra camera da letto?

Tetris door transforms the wardrobe into a picture to be customized.
 Which is the better way to express your taste and make your bedroom unique?



CALLESELLA
 Wood furniture since 1896

Cassettiere, ripiani, porta camicie, appendiabiti...
 è ampissima l'offerta di accessori per allestire al meglio
 l'interno dell'armadio.

Chests of drawers, shelves, shirt trays, clothes rails ...
 there is a wide range of accessories
 to best set up the inside of the wardrobe.



"SEZIONE TECNICA"
"TECHNICAL SECTION"



COMP. 01 PAG. 15

Finiture: Salvia, Pesca, Confetto
 Letto MORFEO con giroletto LARGE per rete 900x1900
 Armadio BUTTERFLY 2 ante PROVENZA e 3 cassetti L.1402 con stampe e pomoli Minou
 Settimanale BUTTERFLY con stampe e pomoli Minou
 Libreria ARTEMIDE con stampe
 Consolle DAFNE con fregio, stampe e pomoli Minou
 Tavolino rotondo BUTTERFLY
 Mensola BUTTERFLY con supporti legno e fregio
 Sedia ADE

Finishes: Salvia, Pesca, Confetto
 MORFEO bed with LARGE bed frame for frame 900x1900
 BUTTERFLY wardrobe 2 PROVENZA doors and 3 drawers W.1402 with prints and Minou knobs
 BUTTERFLY seven-drawer chest with prints and Minou knobs
 ARTEMIDE bookcase with prints
 DAFNE console with frieze, prints and Minou knobs
 BUTTERFLY round small table
 BUTTERFLY shelf with wooden supports and frieze
 ADE chair



COMP. 05 PAG. 43

Finiture: Fango, Canapa
 Letto MORFEO giroletto LARGE con gonna per rete 1600x1900
 Comodino BUTTERFLY 2 cassetti con pomoli Minou
 Comò BUTTERFLY L.1330 con stampa e pomoli Minou
 Armadio BUTTERFLY
 4 ante PROVENZA DOGATA
 3 cassetti L.2604 con stampa, serratura e pomoli Minou
 Specchiera SCILLA H.1130
 Boiserie ROMANTIC DALIA verticale

Finishes: Fango, Canapa
 MORFEO bed LARGE bed frame with skirt for frame 1600x1900
 BUTTERFLY nightstand 2 drawers with Minou knobs
 BUTTERFLY nightstand W.1330 with print and Minou knobs
 BUTTERFLY wardrobe
 4 doors SLATTED PROVENZA
 3 drawers W.2604 with print, lock and Minou knobs
 SCILLA wall mirror H.1130
 ROMANTIC DALIA vertical boiserie



COMP. 02 PAG. 25

Finiture: Shabby Cipria/Magenta, Salvia, Magenta, Cipria
 Letto GENDARME con stampa per rete 900x1900
 Comodino BUTTERFLY 2 cassetti con pomolo Minou
 Comò BUTTERFLY L.1030 con stampe e pomoli Minou
 Armadio BUTTERFLY 2 Ante PROVENZA L.1402 con stampe e pomoli Minou
 Consolle DAFNE con fregio, stampe e pomoli Minou
 Specchiera SCILLA
 Sedia SALLY
 Pensile ATHOS con Fregio

Finishes: Shabby Cipria/Magenta, Salvia, Magenta, Cipria
 GENDARME bed with print for frame 900x1900
 BUTTERFLY nightstand 2 drawers with Minou knob
 BUTTERFLY dresser W.1030 with prints and Minou knobs
 BUTTERFLY wardrobe 2 PROVENZA doors W.1402 with prints and Minou knobs
 DAFNE console with frieze, prints and Minou knobs
 SCILLA wall mirror
 SALLY chair
 ATHOS wall unit with Frieze



COMP. 06 PAG. 47

Finiture: Shabby Carta da Zucchero/Petrolio, Petrolio, Carta da zucchero, Confetto
 Letto ROMANZA per rete 1600x1900
 Comodino BUTTERFLY 1 cassetto e vano giorno con pomolo Rosa
 Comò BUTTERFLY L.1330 con pomoli Rosa
 Libreria ARTEMIDE con stampe
 Specchiera AGAVE
 Specchiera SCILLA H.1130

Finishes: Shabby Carta da Zucchero/Petrolio, Petrolio, Carta da zucchero, Confetto
 ROMANZA bed for frame 1600x1900
 BUTTERFLY nightstand 1 drawer and open compartment with Rosa knob
 BUTTERFLY dresser W.1330 with Rosa knobs
 ARTEMIDE bookcase with prints
 AGAVE wall mirror
 SCILLA wall mirror H.1130



COMP. 03 PAG. 31

Finiture: Shabby Neve/Anice, Carta da Zucchero, Confetto, Neve
 Letto CALIPSO giroletto LARGE con gonna per rete 1200x1900
 Comodino BUTTERFLY 2 cassetti con pomoli Rosa
 Armadio BUTTERFLY 3 ante PROVENZA, 3 cestoni L.2003 e pomoli Rosa
 Specchiera AGAVE
 Tavolino rotondo BUTTERFLY
 Pensile ATHOS con Fregio

Finishes: Shabby Neve/Anice, Carta da Zucchero, Confetto, Neve
 CALIPSO bed with skirt for frame 1200x1900
 BUTTERFLY nightstand 2 drawers with Rosa knobs
 BUTTERFLY wardrobe 3 PROVENZA doors, 3 deep drawers W.2003 and Rosa knobs
 AGAVE wall mirror
 BUTTERFLY round small table
 ATHOS wall unit with Frieze



COMP. 07 PAG. 59

Finiture: Petrolio, Carta da zucchero, Neve, Tabacco, Salvia
 Letto EDONÈ con 3+3 cassetti per rete 1200x2000 con pomoli Bizet
 Cuscino testiera letto con cinghie in cuoio L.1250
 Libreria a giorno per letto EDONÈ L.1322 H.1860
 Settimanale EOS con maniglie Monet
 Armadio massello EVERYDAY ante battenti BRIO, 4 cassetti e vano a giorno L.2460 P.600 H.2220 con maniglie Monet e pomoli Bizet
 Scrivitoio ATLANTE 2 cassetti L.1300 con pomoli Bizet
 Sedia imbottita AISA

Finishes: Petrolio, Carta da zucchero, Neve, Tabacco, Salvia
 EDONÈ bed with 3+3 drawers for frame 1200x2000 with Bizet knobs
 Headboard cushion with leather straps W.1250
 Open bookcase for EDONÈ bed W.1322 H.1860
 EOS seven-drawer chest with Monet handles
 EVERYDAY solid wood wardrobe with BRIO hinged doors, 4 drawers and open compartment W.2460 D.600 H.2220 with Monet handles and Bizet knobs
 ATLANTE desk with 2 drawers W.1300 with Bizet knobs
 AISA upholstered chair



COMP. 04 PAG. 37

Finiture: Shabby Neve/Anice, Fango, Petrolio, Carta da Zucchero, Confetto, Neve
 Divano letto con cassettoni estraibile
 Armadio BUTTERFLY 1 ante PROVENZA L.902 con pomolo Rosa
 Scrivitoio ETHERE 1 cassetto L.1300 con stampa e pomolo Rosa
 Sedia SALLY con gonna e fiocco
 Tavolino rotondo BUTTERFLY
 Pensile ATHOS con Fregio
 Boiserie ROMANTIC DALIA verticale
 Cimasa CLASSICA boiserie DALIA

Finishes: Shabby Neve/Anice, Fango, Petrolio, Carta da Zucchero, Confetto, Neve
 Sofa bed with pull-out storage drawer
 BUTTERFLY wardrobe 1 PROVENZA door W.902 with Rosa knob
 ETHERE desk 1 drawer W.1300 with print and Rosa knob
 SALLY chair with skirt and bow
 BUTTERFLY round small table
 ATHOS wall unit with Frieze
 ROMANTIC DALIA vertical boiserie
 CLASSICA cornice DALIA boiserie



COMP. 08 PAG. 67

Finiture: Petrolio, Carta da zucchero, Anice talcato, Salvia, Tabacco, Neve
 Letto EDONÈ con cassettoni estraibile e 3 cassetti per rete 900x1900 con pomoli Bizet
 Libreria a giorno per letto EDONÈ L.1070 H.1170
 Tavolino ELETTRA
 Scrivitoio ATLANTE 2 cassetti L.1300 con pomoli Bizet
 Sedia Fiore con cuscino
 Cuscino con doppio nervetto per sedia FIORE
 Pensile ATHOS

Finishes: Petrolio, Carta da zucchero, Anice talcato, Salvia, Tabacco, Neve
 EDONÈ bed with pull-out storage drawer and 3 drawers for frame 900x1900 with Bizet knobs
 Open bookcase for EDONÈ bed W.1070 H.1170
 ELETTRA small table
 ATLANTE desk 2 drawers W.1300 with Bizet knobs
 Fiore chair with cushion
 Cushion with double veining for FIORE chair
 ATHOS wall unit



COMP. 9 PAG. 71

Finiture: Anice talcato, Tortora talcato, Fango
 Letto sommier SLIM per rete 900x1900
 Cuscino testiera letto con cinghie in cuoio L.950
 Armadio massello EVERYDAY anta battente
 BRIO con libreria MAIA L.2404 P.1054 H.2220
 con pomoli Bizet
 Scrivitoio ATLANTE L.1500
 Sedia ELETTRA
 Pensile ATHOS L.900 H.360
 Pouff rotondo
 Boiserie EVERYDAY DALIA orizzontale

Finishes: Anice talcato, Tortora talcato, Fango
 SLIM sommier bed for frame 900x1900
 Headboard cushion with leather straps W.950
 EVERYDAY solid wood wardrobe BRIO hinged
 door with MAIA bookcase W.2404 D.1054 H.2220
 with Bizet knobs
 ATLANTE desk W.1500
 ELETTRA chair
 ATHOS wall unit W.900 H.360
 Round pouffe
 EVERYDAY DALIA horizontal boiserie



COMP. 13 PAG. 97

Finiture: Canapa talcato, Pietra
 Letto GENDARME per rete 1600x1900 con gonna
 Comodino EOS 2 cassetti con maniglie Matisse
 Comò EOS L.1300 con maniglie Matisse
 Armadio massello 3 ante scorrevoli BRIO
 con mostrine L.60 L.2820 H.2460
 con maniglia Picasso
 Specchiera KRIS

Finishes: Canapa talcato, Pietra
 GENDARME bed for frame 1600x1900 with skirt
 EOS nightstand 2 drawers with Matisse handles
 EOS dresser W.1300 with Matisse handles
 Solid wood wardrobe 3 BRIO sliding doors with
 W.60 decorated side panels W.2820 H.2460
 with Picasso handle
 KRIS wall mirror



COMP. 10 PAG. 75

Finiture: Anice talcato, Tortora talcato, Canapa
 talcato, Fango
 Letto STELLA con cuscino per rete 1200x1900
 Armadio massello EVERYDAY
 anta battente BRIO con libreria MAIA
 L.2404 P.1054 H.2220 con pomoli Margherita
 Basi libreria MAIA con 2 cestoni
 L.1900 P.605 H.450 con pomoli Margherita
 Scrivitoio EVERYDAY in appoggio su basi
 libreria L.1800 P.600
 Cassettiera con ruote L.450 P.440 H.580
 con pomoli Margherita
 Sedia TALIA
 Pensile ATHOS L.900 H.360
 Pouff rotondo
 Boiserie EVERYDAY DALIA orizzontale

Finishes: Anice talcato, Tortora talcato, Canapa
 talcato, Fango
 STELLA bed with cushion for frame 1200x1900
 EVERYDAY solid wood
 wardrobe BRIO hinged door with MAIA bookcase
 W.2404 D.1054 H.2220 with Margherita knobs
 MAIA bookcase base units with 2 deep drawers
 W.1900 D.605 H.450 with Margherita knobs
 EVERYDAY desk standing on
 bookcase base units W.1800 D.600
 Chest of drawers W.450 D.440 H.580
 with Margherita knobs
 TALIA chair
 ATHOS wall unit W.900 H.360
 Round pouffe
 EVERYDAY DALIA horizontal boiserie



COMP. 14 PAG. 103

Finiture: Canapa talcato, Anice talcato, Pietra
 Letto HELIOS con contenitore e rete 1600x1900
 Cuscino testiera letto con cinghie in cuoio L.1650
 Tavolino ELETTRA
 Comò EOS L.1300 con maniglie Matisse
 Specchiera KRIS
 Sedia SALLY con gonna e fiocco
 Pouff rotondo

Finishes: Canapa talcato, Anice talcato, Pietra
 HELIOS bed with storage unit and frame 1600x1900
 Headboard cushion with leather straps W.1650
 ELETTRA small table
 EOS dresser W.1300 with Matisse handles
 KRIS wall mirror
 SALLY chair with skirt and bow
 Round pouffe



COMP. 11 PAG. 81

Finiture: Salvia talcato, Canapa, Fango
 Letto LUNA per rete 1200x1900
 Comodino EOS 1 cassetto e vano a giorno
 Armadio massello EVERYDAY
 anta battente BRIO con cimasa COUNTRY
 L.2887 P.2089 H.2220 con sopralzi pensile
 Pensile ATHOS
 Sedia AISA
 Boiserie EVERYDAY DALIA verticale

Finishes: Salvia talcato, Canapa, Fango
 LUNA bed for frame 1200x1900
 EOS nightstand 1 drawer and open compartment
 EVERYDAY solid wood wardrobe BRIO hinged
 door with COUNTRY cornice
 W.2887 D. 2089 H.2220 with overhead wall units
 ATHOS wall unit
 AISA chair
 EVERYDAY DALIA vertical boiserie



COMP. 15 PAG. 111

Finiture: Petrolio, Grafite, Timo
 Letto sommier INDIO per rete 1200x1900
 Testiera imbottita AZOTO L.1510
 Comodino BERILLIO L.450
 Armadio FLY con 2 ante,
 3 cassetti e vano giorno L.1660 P.590 H.1940
 Scrivitoio URANIO con 2 cassetti L.1500
 Panca PALLADIO con cuscino
 Cuscino con doppio nervetto per
 panca PALLADIO
 Specchiera XENON

Finishes: Petrolio, Grafite, Timo
 INDIO sommier bed for frame 1200x1900
 AZOTO upholstered headboard W.1510
 BERILLIO nightstand W.450
 FLY wardrobe with 2 doors,
 3 drawers and open compartment W.1660 D.590 H.1940
 URANIO desk with 2 drawers W.1500
 PALLADIO bench with cushion
 Cushion with double veining for
 PALLADIO bench
 XENON wall mirror



COMP. 12 PAG. 85

Finiture: Fango, Tabacco, Magenta,
 Pesca, Confetto
 Letto EDONÈ cassettoni estraibile
 per rete 800x1900 maniglia Monet
 Letto sbalzo APOLLO con scala gradoni e
 armadietti 3 cestoni L.2480 P.1060 H.1650
 con maniglie Monet e pomoli Bizet
 Scrivitoio ATLANTE L.1800 P.630
 con 2 pensili ATHOS L.600 H.450
 Sedia ADE
 Pensile ATHOS

Finishes: Fango, Tabacco, Magenta,
 Pesca, Confetto
 EDONÈ bed pull-out storage drawer
 for frame 800x1900 Monet handle
 APOLLO cantilevered bed with staircase and
 cabinets 3 deep drawers W.2480 D.1060 H.1650
 with Monet handles and Bizet knobs
 ATLANTE desk W.1800 D.630
 with 2 ATHOS wall units W.600 H.450
 ADE chair
 ATHOS wall unit



COMP. 16 PAG. 117

Finiture: Tabacco, Carta da zucchero, Cotone
 Letto COBALTO testiera imbottita
 per rete 900x1900
 Comodino ARGON 1 cassetto L.680
 Settimanale ARGON L.680
 Pensile ATHOS
 Scrivitoio URANIO gamba metallo L.1800 P.600
 Pensile anta ribalta Everyday L.600 H.360
 Sedia PENELOPE
 Cuscino con doppio nervetto per sedia Penelope
 Libreria TITANIO con 4 mensole e
 1 pensile L.1880 P.282 H.893

Finishes: Tabacco, Carta da zucchero, Cotone
 COBALTO bed upholstered headboard
 for frame 900x1900
 ARGON nightstand 1 drawer W.680
 ARGON seven-drawer chest W.680
 ATHOS wall unit
 URANIO desk metal leg W.1800 D.680
 Everyday tilt&turn wall unit W.600 H.360
 PENELOPE chair
 Cushion with double veining for Penelope chair
 TITANIO bookcase with 4 shelves and
 1 wall unit W.1880 D.282 H.893



COMP. 17 PAG. 125

Finiture: Tea, Pesca, Confetto, Cotone
 Letto SELENIO con cuscino per rete 900x1900
 Panchetta ARGON L.980 P.440 con elemento 1 cassetto L.600
 Armadio massello EVERYDAY 4 ante battenti EASY L.2430 P.600 H.2460
 Scrivitoio URANIO con alzatina L.1500
 Panca PALLADIO
 Cuscino con doppio nervetto per panca PALLADIO
 Libreria TITANIO con 10 mensole e 3 pensili L.2840 P.282 H.1883

Finishes: Tea, Pesca, Confetto, Cotone
 SELENIO bed with cushion for frame 900x1900
 ARGON bench W.980 D.440 with 1 drawer unit W.600
 EVERYDAY solid wood wardrobe 4 EASY hinged doors W.2430 D.600 H.2460
 URANIO desk with backplash W.1500
 PALLADIO bench
 Cushion with double veining for PALLADIO bench
 TITANIO bookcase with 10 shelves and 3 wall units W.2840 D.282 H.1883



COMP. 18 PAG. 133

Finiture: Timo, Grafite, Opale, Tabacco
 Letto CROMO per rete 900x1900
 Comodino ARGON 1 cassetto L.530
 Armadio ARGON 2 Ante L.1280 H.2000
 Libreria FLY con 3 cassetti e scrivitoio L.2750 P.600 H.1940
 Pouff rotondo

Finishes: Timo, Grafite, Opale, Tabacco
 CROMO bed for frame 900x1900
 ARGON nightstand 1 drawer W.530
 ARGON wardrobe 2 doors W.1280 H.2000
 FLY wardrobe with 3 drawers and desk W.2750 D.600 H.1940
 Round pouffe



COMP. 19 PAG. 141

Finiture: Opale ecologico, Tea ecologico, Grafite
 Letto sommier INDIO per rete 1600x1900
 Testiera imbottita AZOTO L.2040
 Comodino ARGON 2 cassetti L.530
 Comò ARGON L.980
 Armadio massello 3 ante scorrevoli TETRIS con mostrine L.15 L.2730 H.2460 con maniglie Camille
 Specchiera RADON

Finishes: Opale ecologico, Tea ecologico, Grafite
 INDIO sommier bed for frame 1600x1900
 AZOTO upholstered headboard W.2040
 ARGON nightstand 2 drawers W.530
 ARGON dresser W.980
 Solid wood wardrobe 3 TETRIS sliding doors with W.15 side panels W.2730 H.2460 with Camille handles
 RADON wall mirror

TESSUTI / FABRICS



EXCLUSIVE 102



EXCLUSIVE 406



EXCLUSIVE 900

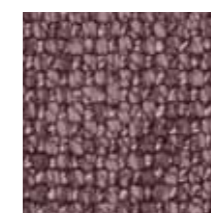

EXCLUSIVE 905



EXCLUSIVE 315



EXCLUSIVE 705



LEVANTE 406



LEVANTE 905



LEVANTE 900



LEVANTE 001



LEVANTE 805

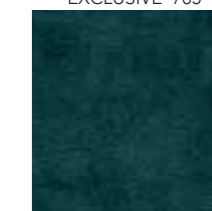

LEVANTE 710



LEVANTE GEOM. 406



LEVANTE GEOM. 905



LEVANTE GEOM. 805



LEVANTE GEOM. 710

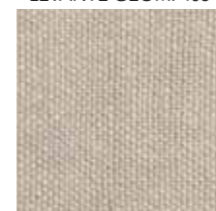

PUROLINO 04

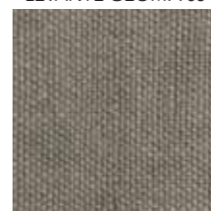

PUROLINO 31



PUROLINO 24



PUROLINO 64

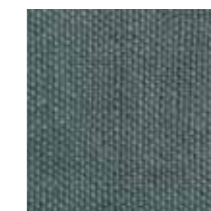

PUROLINO 45

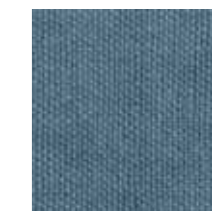

PUROLINO 47

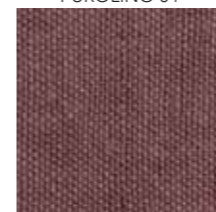

PUROLINO 49

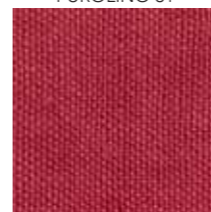

PUROLINO 39



PUROLINO 55



PUROLINO 21

LETTI IMBOTTITI / UPHOLSTERED BEDS

Tutti i letti sono disponibili per rete da 900/1200/1600/1800/2000
 All the beds are available for frame 900/1200/1600/1800/2000



Morfeo giroletto Slim.
Morfeo, Slim bed frame.



Morfeo giroletto Slim, con gonna.
Morfeo, Slim bed frame with skirt.



Morfeo giroletto large.
Morfeo, large bed frame.



Morfeo giroletto large, con gonna.
Morfeo large bed frame with skirt.

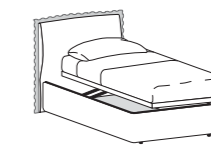

Morfeo con contenitore, giroletto large.
Morfeo with storage unit, large bed frame.

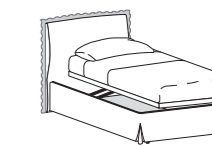

Morfeo con contenitore, gonna e giroletto large.
Morfeo with storage unit, skirt and large bed frame.



Calipso giroletto Slim.
Calipso, Slim bed frame.



Calipso giroletto Slim, con gonna.
Calipso, Slim bed frame with skirt.



Calipso giroletto large.
Calipso, large bed frame.



Calipso giroletto large, con gonna.
Calipso, large bed frame with skirt.



Calipso con contenitore, giroletto large.
Calipso with storage unit, large bed frame.



Calipso con contenitore, gonna e giroletto large.
Calipso with storage unit, skirt and large bed frame.

ROMANTIC ROOM / ROMANTIC ROOM

Finiture laccato liscio / Smooth lacquered finishes



Finiture shabby / Shabby finishes



Stampa / Print



LETTI IN LEGNO / WOODEN BEDS

Tutti i letti (tranne Romanza) sono disponibili per rete da 900/1200/1600/1800/2000
All the beds (without Romanza) are available for frame 900/1200/1600/1800/2000

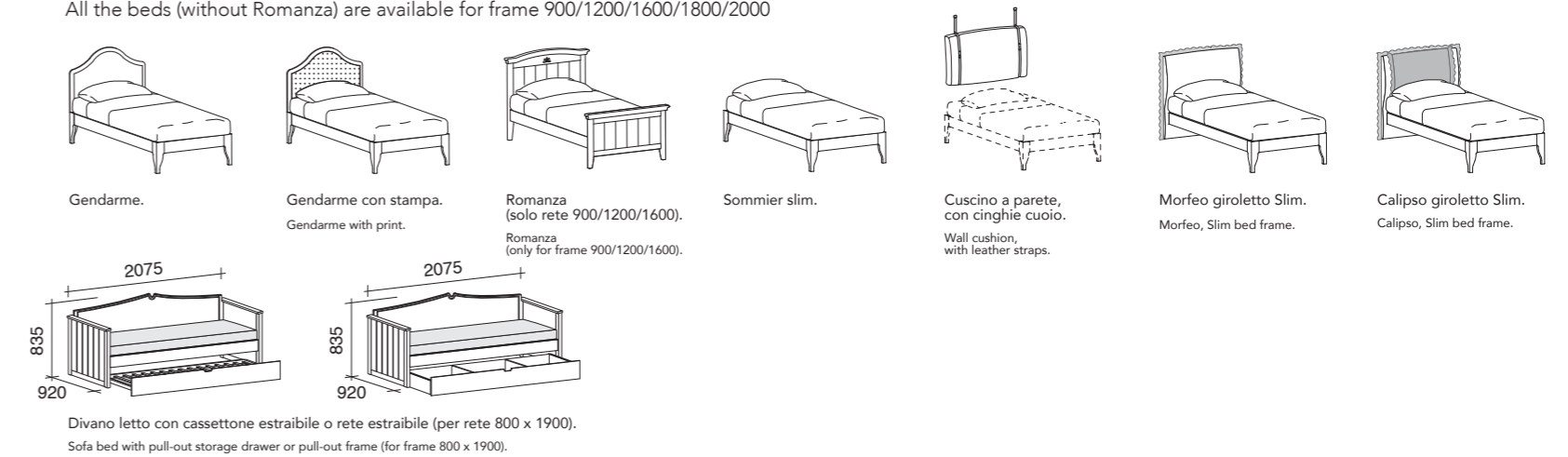

GRUPPO LETTO BUTTERFLY / BUTTERFLY ACCESSORIES

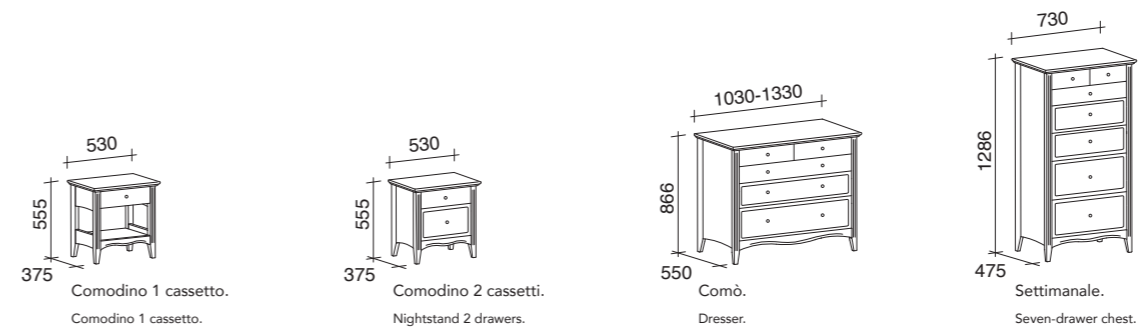

ARMADI / WARDROBES

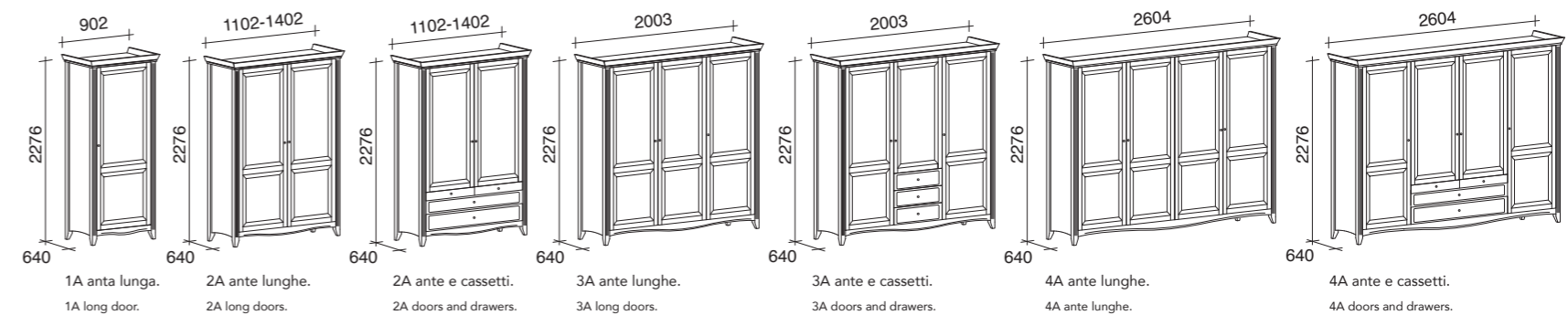

COMPONIBILI / MODULAR WARDROBES

Elemento da 450/600/900/1200 h. 2220/2460, 2 fianchi
Module 450/600/900/1200 h. 2220/2460, 2 sides

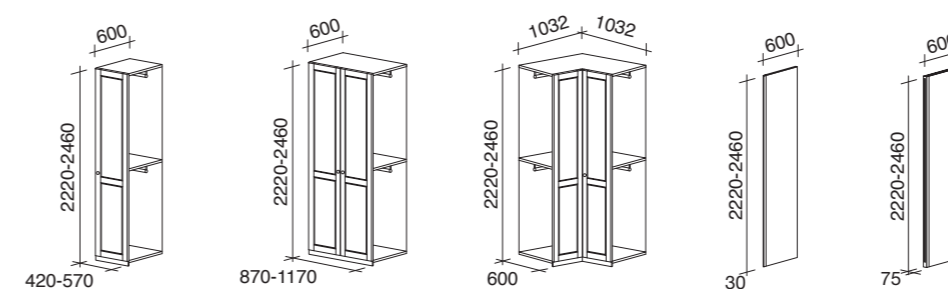

EVERY DAY & URBAN

Tinte / Colours



Laccati spazzolati / Brushed lacquered colours



Talcati / Talced colours



Invecchiati / Distressed colours



Finitura ecologica / Ecological finish



Usurati / Worn-look colours



VERNICI ECOLOGICHE / ECOLOGICAL PAINTS

Per Every Day e Urban Time sono disponibili vernici ecologiche ricavate da sostanze vegetali non raffinate, come l'olio di lino e la cera di carnauba, e materie prime di origine controllata. **Non contengono formaldeide** e suoi precursori, derivati dal petrolio, né metalli pesanti. Garantiscono durata, resa estetica, resistenza e applicabilità top di gamma.

Le nostre vernici ecologiche vantano **zero emissioni di composti organici volatili**, contribuendo alla riduzione dell'effetto serra.

Sono inoltre prodotte in impianti alimentati da **energia pulita e rinnovabile**.

For Every Day and Urban Time are available **ecological paints made from unrefined vegetable substances**, such as linseed oil and carnauba wax, and raw materials of controlled origin.

They do not contain formaldehyde and its precursors, petroleum derivatives, nor heavy metals. They guarantee durability, aesthetics, resistance and top-of-the-range applicability.

Our ecological paints boast **zero emissions of volatile organic compounds**, contributing to reduce the greenhouse effect.

They are also produced in plants powered by **clean and renewable energy**.

LETTI / BEDS

Tutti i letti, tranne il luna Indio, Selenio, Cobalto, Cromo, Edone, sono disponibili x rete da 900/1200/1600/1800/2000. All the beds, except for Luna, Indio, Selenio, Cobalto, Cromo, Edone, are available for frame 900/1200/1600/1800/2000.

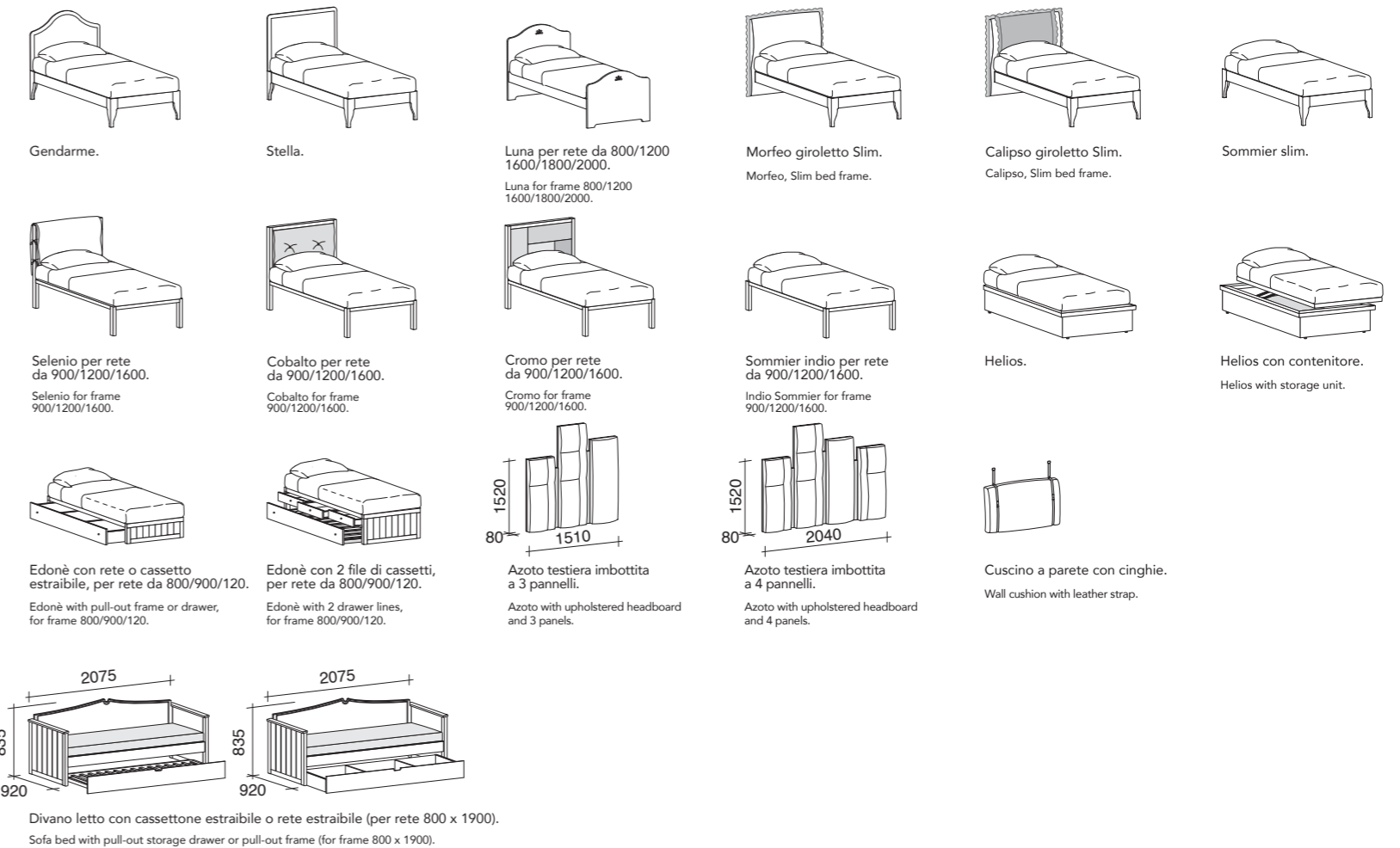

GRUPPO LETTO EOS / EOS ACCESSORIES

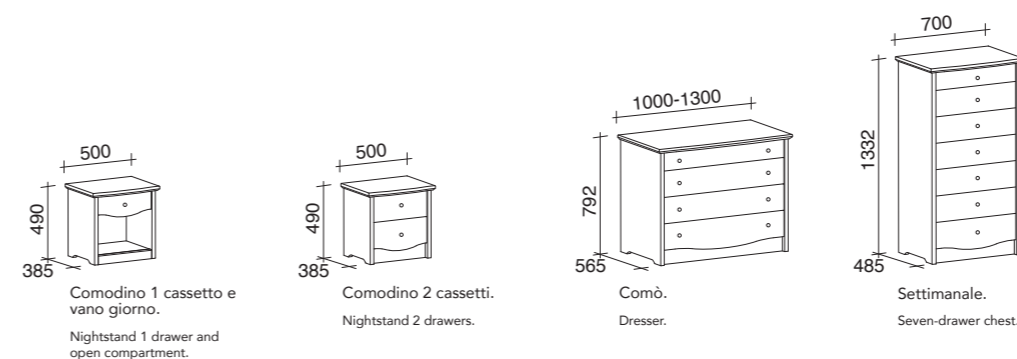

GRUPPO LETTO ARGON / ARGON ACCESSORIES

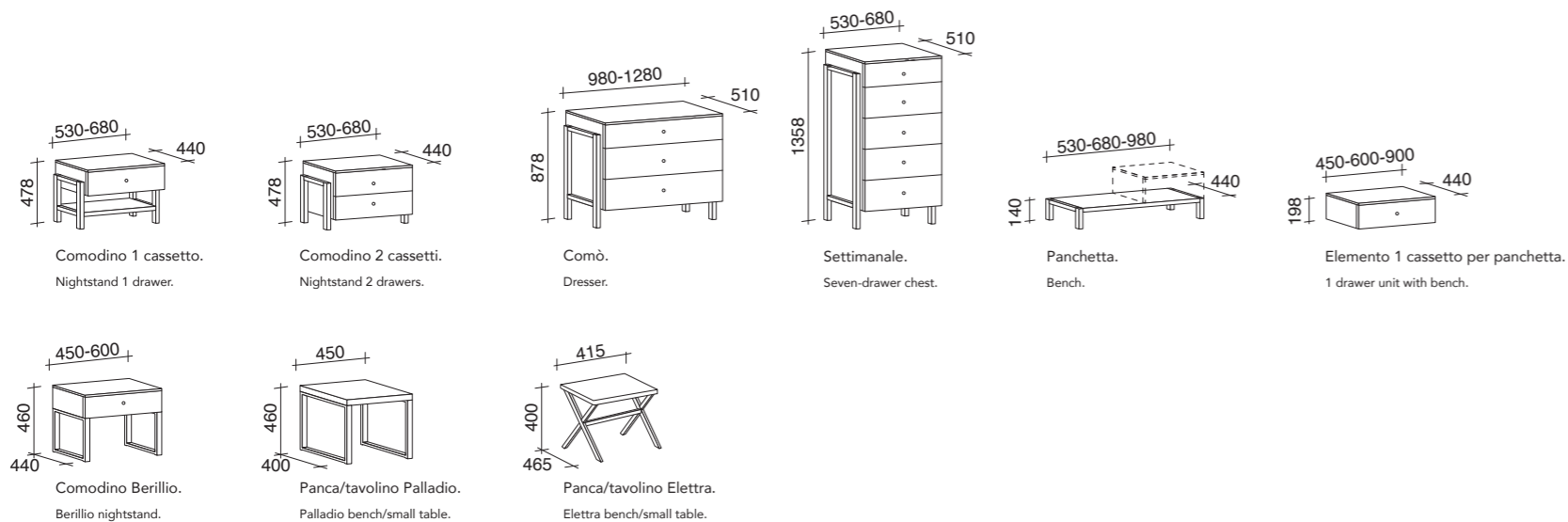

ARMADI ARGON / ARGON WARDROBES

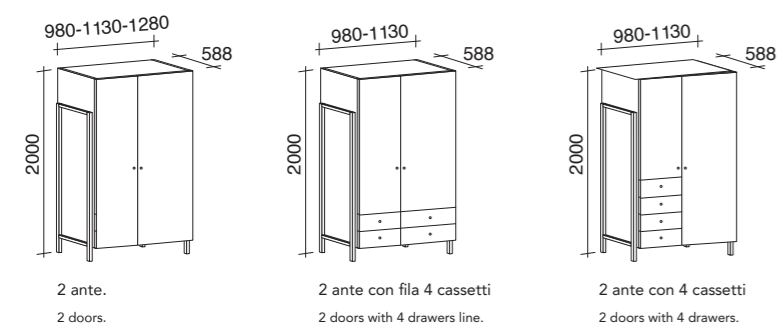

COMPONIBILI ANTA SCORREVOLE / MODULAR WARDROBES WITH SLIDING DOOR

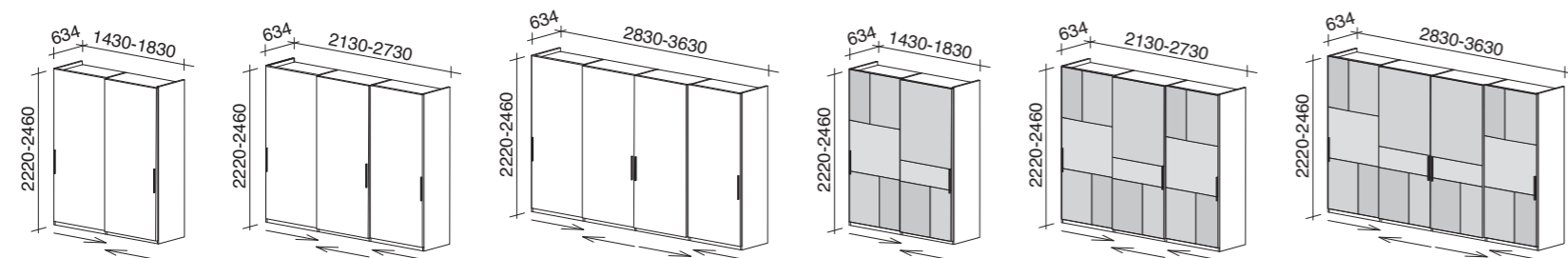

COMPONIBILI ANTA BATTENTE / MODULAR WARDROBES WITH HINGED DOOR

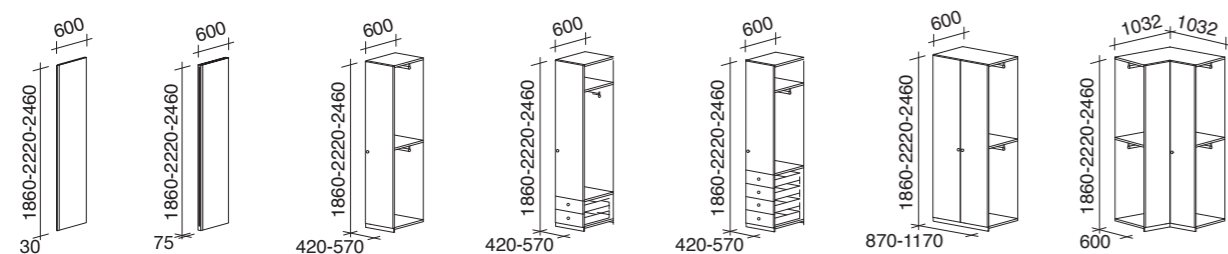

AT HOME

infinite atmospheres

