

LIGHT UP YOUR LIFE

SINCE 1942

ALPHABETICAL ALFABÉTICO 6
 SUSPENSION LAMPS LÁMPARAS DE SUSPENSIÓN 8
 FLOOR LAMPS LÁMPARAS DE PIE 10
 TABLE LAMPS LÁMPARAS DE MESA 12
 CEILING LAMPS PLAFONES 13
 WALL LAMPS LÁMPARAS DE PARED 14
 COMBINATIONS COMBINACIONES 254
 BULBS BOMBILLAS 258
 SCROLLINGS DESPLAZAMIENTOS 259
 GENERAL SPECIFICATIONS CARACTERÍSTICAS GENERALES 260
 FINISHES ACABADOS 262

A

ATHINA 148
 ATRIUM 152
 AURA 212

B

BERKA 192
 BLUR 166
 BORROCO 172
 BUBLE 206
 BULB 126
 BULBO 30

C

CIRCA 216
 CLUB 122

D

DLED 232
 DLED SHADE 234
 DONA 170

E

ECLIPSE 44
 ELEGANCE 176
 ESTIU 22
 EXA 184

F

FALGA 94
 FUSTA 154

G

GARLAND 198
 GIRA 134
 GLASSY 210
 GRACE 18

H

HANG OUT 74
 HAT 180
 HOLD 144

I

IN OPAQUE 62
 IN TRANSLUCENT 68
 INFINITO 82

K

KANATAN 130

L

LAFFIE 108
 LARA 116
 LITE 188
 LOB 26
 LOULU 86
 LOUVRE 120
 LUCETA 38
 LLUNA 98

M

MANHATTAN 160
 MINA 158
 MOON 102

N

NAAF 226
 NORDIC 34

P

PEA 90
 PETIT 222
 POPPOL 202
 PURA 218

Q

QUO 228

S

SHAPE 238
 SIMPLICITY 240
 SIXTIE 138

T

TO BE 164

V

VALLISE 142
 VERSUS 40
 VOLUM OPAQUE 50
 VOLUM TRANSLUCENT 58

Z

ZESTA 78



AURA 213



BERKA 193



BLUR 167



BORROCO 173



IN OPAQUE 63 / TRANSLUCENT 69



INFINITO 84



KANATAN 131



BUBLE 207



BULB 127



BULBO 31



CLUB 123



LAFFIE 109



LARA 117



LITE 189



LOB 27

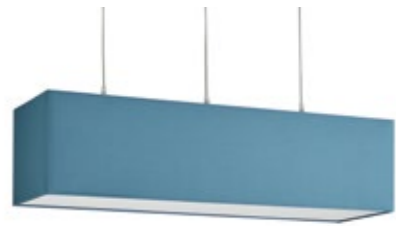

DONA 170



ELEGANCE 176



LUCETA 38



LLUNA 98



MANHATTAN 161



MOON 103



ESTIU 23



EXA 185



GARLAND 199



GLASSY 210



NAAF 226



NORDIC 35



PEA 91



POPPOL 203



GRACE 19



HANG OUT 75



HAT 181



SIMPLICITY 241



TO BE 164



VERSUS 41

CAT.34



ATHINA 150 **ATRIUM** 152 **BERKA** 196



CLUB 124 **EXA** 185 **FALGA** 96



FUSTA 155 **GIRA** 135 **HAT** 181 **HOLD** 145

INDEX ÍNDICE



INFINITO 83 **KANATAN** 131 **LOULU** 87



MANHATTAN 161 **MINA** 158 **NAAF** 227



PETIT 223 **QUO** 231 **SIXTIE** 139 **VALLISE** 142

FLOOR LAMPS LÁMPARAS DE PIE

FLOOR LAMPS LÁMPARAS DE PIE



ATHINA 149



BERKA 196



BORROCO 173



LLUNA 99



MANHATTAN 161



NAAF 227



BULB 129



BULBO 31



CLUB 124



NORDIC 35



PEA 91



PETIT 223



EXA 185



FALGA 95



GARLAND 201



QUO 229



SIMPLICITY 253



SIXTIE 139



GIRA 135



HAT 181



INFINITO 83



VALLISE 143



VERSUS 42



KANATAN 131



LOULU 87



CIRCA 216



FALGA 97



IN OPAQUE 64 / TRANSLUCENT 69



LARA 117



LLUNA 99



MANHATTAN 161



NORDIC 35



PURA 219



SIMPLICITY 248

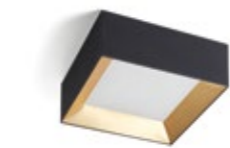

VOLUM OPAQUE 51 / TRANSLUCENT 59



ZESTA 79



BERKA 194



CLUB 122



CIRCA 216



DLED 232



DLED SHADE 235



ECLIPSE 45



EXA 185



GIRA 135



KANATAN 131



LARA 117



LLUNA 99



LOUVRE 121



MANHATTAN 161



NORDIC 35



PEA 91



SHAPE 238



SIMPLICITY 252



ZESTA 79



GRACE

2020 by Aranda Aloy Enblanc

Grace collection is known by its versatility and the use of the rope that defines its design and creates a complicity with glassshade and wood. It allows visibility and introduce light, so comfortable ambiances are created. Its design reminds the shape of the sunhat "pamela". Available in different sizes and colors, gives possibility to create several combinations.

La colección Grace destaca por su versatilidad y uso de la cuerda, la cual dibuja y define formalmente su diseño, guardando complicidad con la tulipa y la madera permitiendo su visibilidad y da paso a la luz, generando así ambientes cálidos y confortables. Su diseño recuerda a la forma de una pamela. Disponible en varios tamaños, colores y con la posibilidad de la realización de diferentes combinaciones.

MASSMI



Suspension lamp
Lámpara de suspensión
[Ref 6015-40 VE HA](#)
[Ref 6015-40 TE HA](#)
[Ref 6015-60 MA HA-NE](#)



Suspension lamp
Lámpara de suspensión
[Ref 6015-40 VE HA](#) [Ref 6015-60 MA HA-NE](#) [Ref 6015-40 TE HA](#) [Ref 6015-90 VE HA-NE](#)

SINCE 1942

Ceiling lamp / Suspensión

Ref 6015-90

LED 3 x 11W **A+**

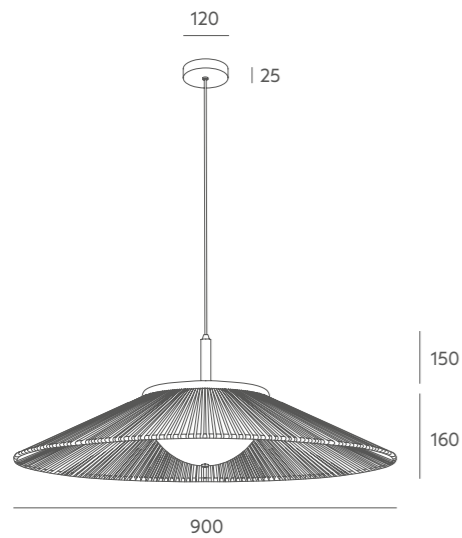

Ref 6015-60

LED 3 x G9 4W **A+**

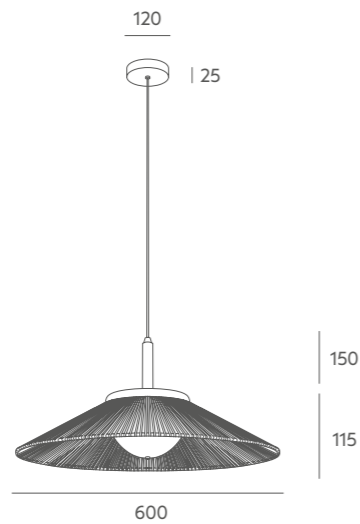

Ref 6015-40

LED 3 x G9 4W **A+**

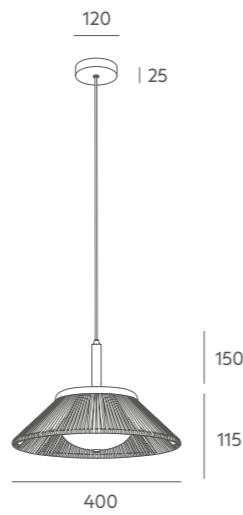

Tecnical data

Frame: : braided rope. Varnished beech wood. Black metal canopy.

Details: opal metacrylate diffuser. Black PVC cable.

Recommended Bulb: Ref 6015 - 90 E-27 11W LED (not included). Ref 6015 - 40 - 60 G9 4W 3000K. 400 Lm 36° LED (included).

Important: the standard cable length is 1 metre, if you need special size please contact our Customer Support Department.

Información técnica

Cuerpo: cuerda trenzada. Madera de haya barnizada. Florón de metal negro.

Detalles: difusor de metacrilato opal. cable PVC negro.

Bombilla recomendada: Ref 6015 - 90 E-27 11W LED (no incluida). Ref 6015 - 40 - 60 G9 4W 3000K. 400 Lm 36° LED (incluida).

Importante: la longitud del cable estándar es de 1 metro, si desea una medida especial no dude en ponerse en contacto con nosotros.

Finishes Acabados

String Colour / Acabado cuerda

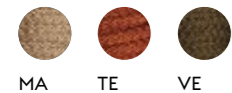

Methacrylate / Metacrilato



Wood / Madera



Metal Colour / Acabado Metal

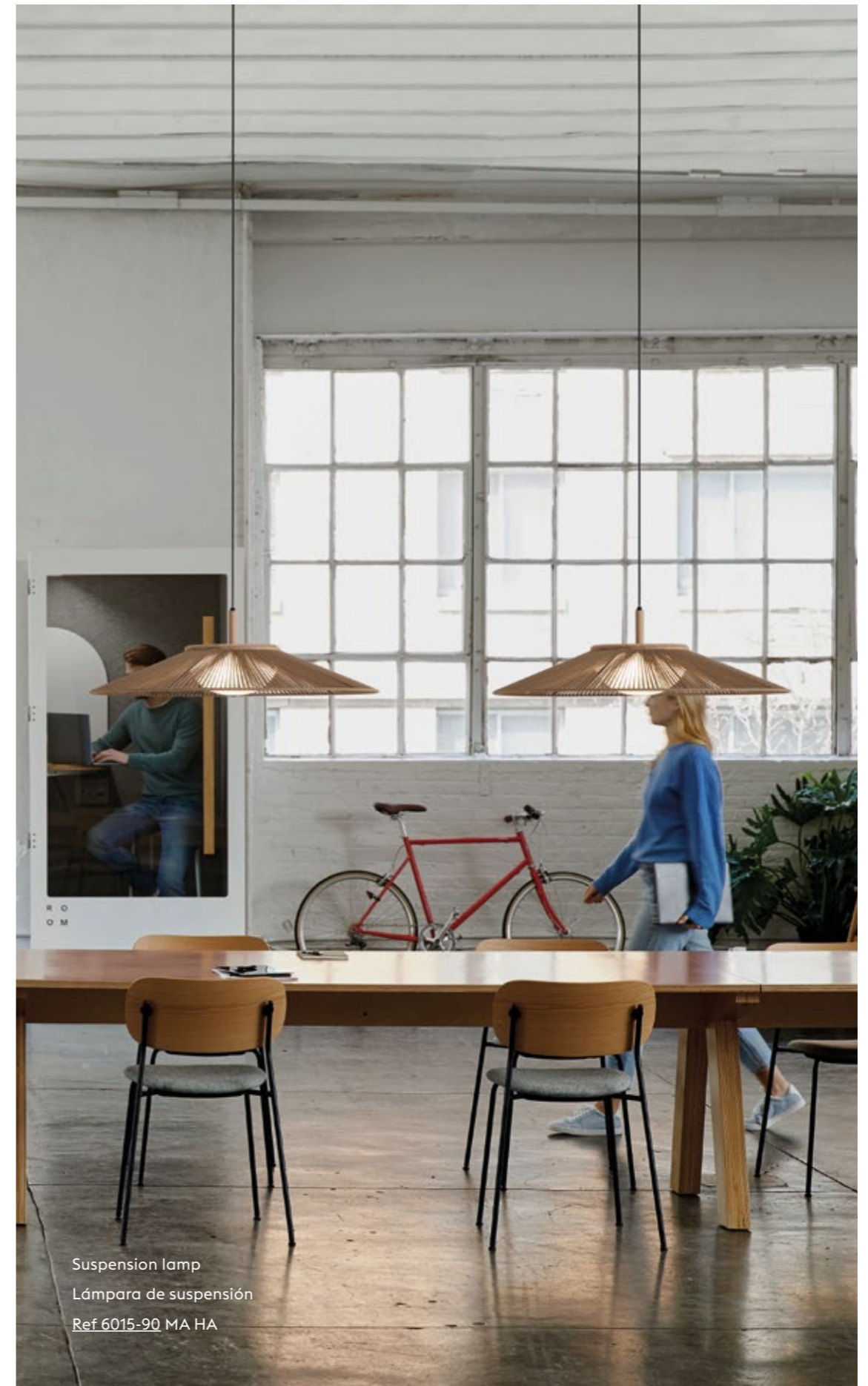

Suspension lamp
Lámpara de suspensión
Ref 6015-90 MA HA

ESTIU

2020 by Aranda Aloy Enblanc

Estiu combines the rope as technical material with the cotton of two cylindrical shades which seems to be floating on the air. Its light and shape move us to a summer nightfall where lanterns are protagonist. Available in different sizes and colors, allow us to create several combinations.

Estiu combina la técnica de cuerda con el algodón de una pantalla cilíndrica de sujeción interna que parece flotar en el aire. Su luz y forma nos traslada a un anochecer de verano donde los farolillos son los protagonistas. Disponible en varios tamaños, colores y con la posibilidad de la realización de diferentes combinaciones.

MASSMI



Rope color details
Detalle colores cuerda



Suspension Lamps
Lámparas de suspensión
Ref. 6017 MA

SINCE 1942



Example composition / Ejemplo composición
G434-45 + Ref 6016 VE + Ref 6017 VE + Ref 6018 VE
 LED 3 x 11W **A+**

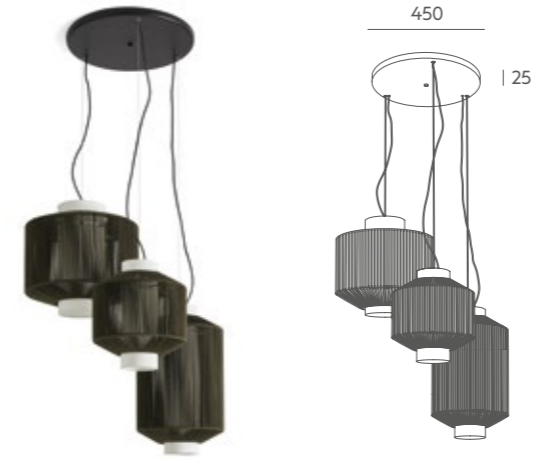

more compositions in page 254 / Más composiciones en página 254

Ceiling lamp / Suspensión
Ref 6017
 LED 1 x 11W **A+**

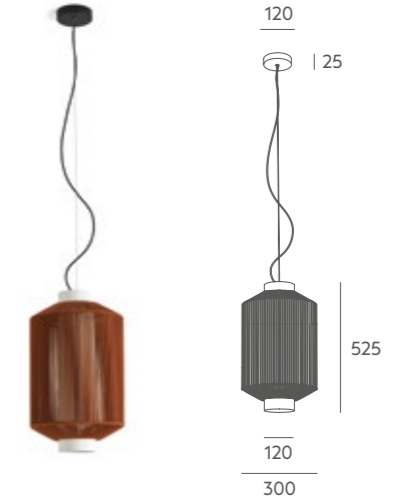

Ref 6018
 LED 1 x 11W **A+**



Ref 6016
 LED 1 x 11W **A+**







Tecnichal data

Frame: braided rope. Black metal canopy.
 Details: translucent beige cotton shade. Steel cable + black PVC cable.
 Recommended Bulb: E-27 11W LED (not included).
 Important: the standard cable length is 2 metre, if you need special size please contact our Customer Support Department.

Información técnica

Cuerpo: cuerda trenzada. Florón de metal negro.
 Detalles: pantalla de tela de algodón crema traslúcido. Cable de acero + cable PVC negro.
 Bombilla recomendada: E-27 11W LED (no incluida).
 Importante: la longitud del cable estándar es de 2 metros, si desea una medida especial no dude en ponerse en contacto con nosotros.

Finishes Acabados

String Colour / Acabado cuerda	Shade / Pantalla	Metal Colour / Acabado Metal
  		
MA TE VE	CR	NMT



Suspension lamps
 Lamparas de suspensión
G434-45 + Ref 6016 VE + Ref 6017 VE + Ref 6018 VE

LOB

2018 by Fluzo Project

It suggests an impossible idea: to catch the light. It has a hanging system made of natural leather including a lighting sphere floating in the space with an elegant aesthetic. LOB gives to its nucleus the complete importance. It's a perfect lighting for home or contract projects as well.

Insinúa una idea imposible: atrapar la luz. Tiene un sistema de sujeción en piel natural que permite incluir una esfera de luz flotando en el espacio con una estética elegante. LOB proporciona a su núcleo toda la importancia. Sus líneas atemporales hacen de esta lámpara un modelo perfecto para espacios domésticos e instalaciones.



MASSMI

SINCE 1942

Ref 6943-30
Suspension lamp
Lámpara de suspensión

Suspension lamps / Lámparas de suspensión

Ref 6943-30

LED 1 x 11W **A+**

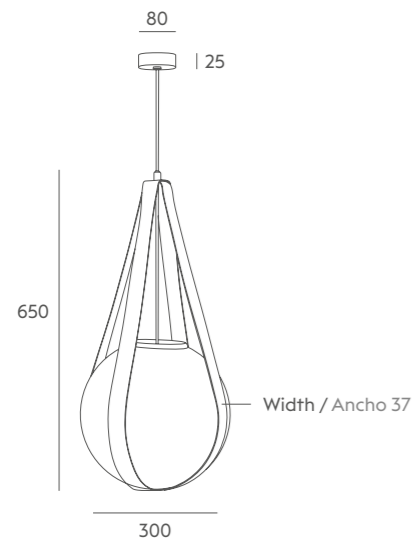

Ref 6943-25

LED 1 x 11W **A+**

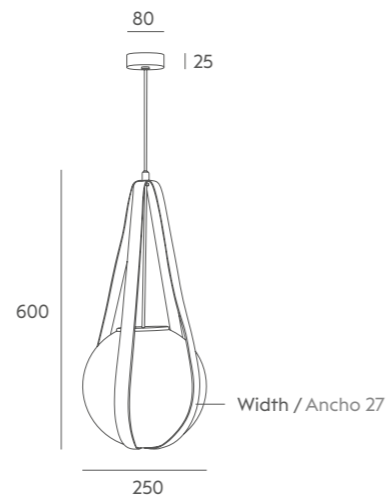

Tecnical data

Frame: satin gold coated iron metal. Chocolate leather colour.

Details: opal mate glasses fixed by nuts. Black PVC cable.

Recommended Bulb: E27 11W LED (not included).

Important: standard length of wire is 1 metre, if you need special length please contact us. We can evaluate to change colour of leather for projects with a minimum quantity of pieces, please check with us.

Finishes Acabados

Glass / Cristal



Leather / Piel



Metal Colour / Acabado Metal



Información técnica

Cuerpo: metal hierro bañado oro satinado. Piel color chocolate.

Detalles: tulipas opal mate cogida con tornillos. Cable negro PVC.

Bombilla recomendada: E27 11W LED (no incluida).

Importante: la longitud del cable estándar es de 1 metro, si desea una medida especial no dude en ponerse en contacto con nosotros. Se puede valorar cambio de color en la piel para proyectos con un mínimo de unidades, no duden en consultarnos.



Suspension lamp

Lámpara de suspensión

Ref 6943-30



BULBO

2018 by XOP // Studio

Bulbo it's a lighting collection based on simplicity and timelessness. The design is a commitment to the functional sobriety by using natural materials as the diffuser made of white matte glass and the small wooden base, who balances the natural simplicity of the collection.

Colección de lámparas basada en la sencillez y la atemporalidad. Con este diseño se pretende hacer una apuesta por la sobriedad funcional utilizando materiales nobles, como el difusor diseñado en vidrio blanco matizado y una pequeña base de madera de roble macizo que le confiere carácter además de equilibrar la sencillez natural de la colección.

MASSMI



SINCE 1942

Suspensión lamps
Lámparas de suspensión
[Ref 6012-P](#) [Ref 6012-G](#)

Table lamp
Lámparas de mesa
[Ref 4002-G](#) [Ref 4002-P](#)



Suspension lamp
Lámpara de suspensión
Ref 6012-G

Table lamp
Lámpara de mesa
Ref 4002-P

Suspension lamps / Lámparas de suspensión

Ref 6012-G

LED 1 x 11W **A+**



Ref 6012-P

LED 1 x 7W **A+**

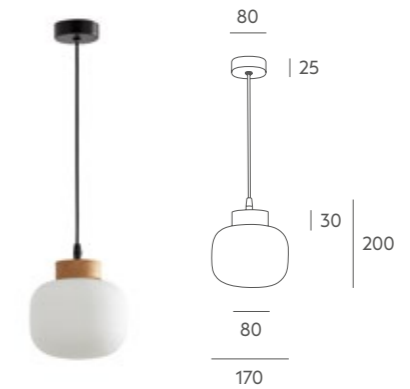
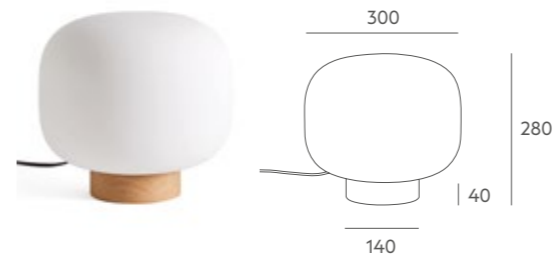

Table lamps / Lámparas de mesa

Ref 4002-G

LED 1 x 11W **A+**



Ref 4002-P

LED 1 x 7W **A+**

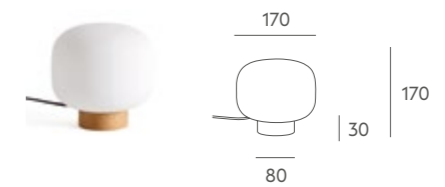

Tecnical data

Frame: : varnished oaky wood. Black metal canopy.
Details: clip opal mate glasses. Black PVC cable.

Recommended Bulb: big Size E-27 11W LED. Small Size E-27 7W LED (not included).

Important: standard length of cable is 1 metre, if you need special length please contact us. We can evaluate to change colour of wood for projects with a minimum quantity of pieces, please check with us.

Finishes Acabados

Glass / Cristal



Wood / Madera



Metal Colour / Acabado Metal



Información técnica

Cuerpo: madera de roble barnizada. Florón de metal negro.
Detalles: tulipas opal mate cogida con pinzas. Cable PVC negro.

Bombilla recomendada: tamaño Grande E-27 11W LED. Tamaño pequeño E-27 7W LED (no incluida).

Importante: la longitud del cable estándar es de 1 metro, si se desea una medida especial póngase en contacto con nosotros. Se puede valorar cambio en el color de la madera para proyectos con un mínimo de unidades, no duden en consultarnos.



NORDIC

2015 by Massmi

Our new version of "Infinito" is a homage to Scandinavian style, which revolutionized the design world with its use of noble materials, especially wood. Made of wood and is available in either natural beech or bleached ash.

Con Nordic hacemos nuestro pequeño homenaje al estilo escandinavo que tanto ha aportado al diseño y la decoración en el empleo de materiales nobles, en particular la madera. La pantalla está realizada en dos tipos de madera a elegir, haya natural y fresno tintado en blanco.

MASSMI



Wall lamp
Lámpara de pared
Ref 1504 BL



Ceiling lamps
Plafones
Ref 3503-70 BL
Ref 3503-25 HA
Ref 3503-50 HA
Ref 3503-25 BL

Suspension lamp
Lámpara de suspensión
Ref 6802 BL

Table lamp
Lámpara de mesa
Ref 4432 P BL

Wall lamps
Lámparas de pared
Ref 1503 HA
Ref 1504 HA

SINCE 1942

Suspension lamp / Lámpara de suspensión

Ref 6802

LED 3 x 7W **A+**

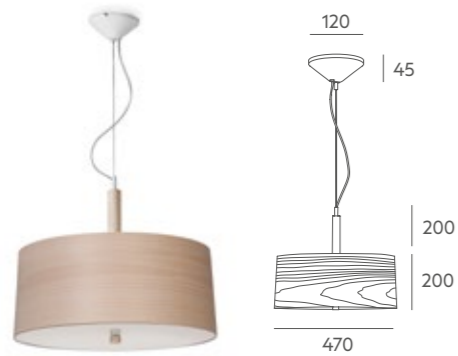
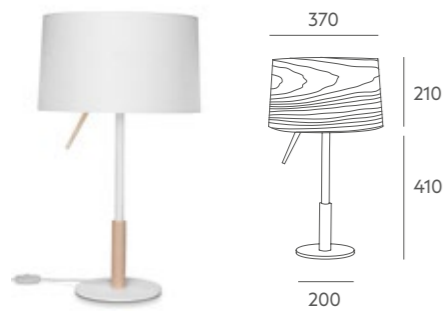

Table lamps / Lámparas de mesa

Ref 4432 G

LED 2 x 7W **A+**



Wall lamps / Lámparas de pared

Ref 1503

LED 1 x 7W **A+**

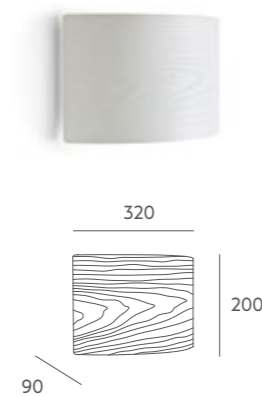

Ref 1504

LED 1 x 7W **A+**



Ref 4432 P

LED 2 x 7W **A+**

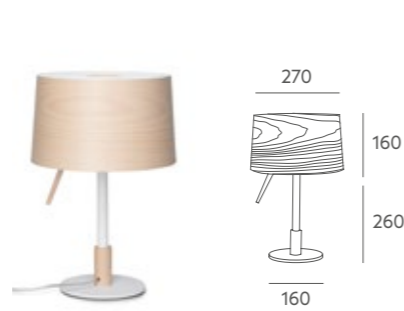

Ceiling lamp / Plafón

Ref 3503

LED Ø 25, 2 x 7W
LED Ø 50, 2 x 11W
LED Ø 70, 4 x 11W **A+**

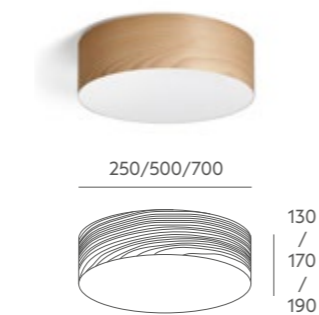

Tecnical data

Frame: matte white or matte black painted iron metal, combined with beech wood.

Details: natural beech wood or white painted ash-tree wood shade. Transparent PVC cable. Beech wood handle and ornament. The pendant has glass diffuser. Opal metacrylate diffuser for ceiling lamps. Table lamp and floor lamp are adjustable by using a knee cap. This collection has a special support. The big table lamp has not diffuser. The small table lamp use a partial disc to cover the sockets. Ceiling lamp with stone sockets and magnet system to hang the shade.

Recommended Bulb: E-27 7W or 11W LED (not included).

Important: standard length of cable is 1 metre, if you need special length please contact us. We can evaluate to change colour of wood for projects with a minimum quantity of pieces, please check with us.

Finishes Acabados

Shade / Pantalla



BL HA

Methacrylate or glass/ Metacrilato o cristal



OP

Metal Colour / Acabado Metal



BMT



Información técnica

Cuerpo: metal hierro pintado en blanco mate texturado combinado con madera de haya.

Detalles: pantalla madera natural de haya o fresno tintado en blanco. Cable transparente PVC. Asa y remate de madera en haya. La lámpara de suspensión lleva difusor de cristal. Plafones difusor metacrilato opal. Los sobremesa son basculantes mediante una rótula. Toda la familia lleva una cogida especial. La lámpara de mesa grande no lleva difusor. La lámpara de mesa pequeña lleva un disco parcial para tapar los portalámparas. Versión plafón, portalámparas de piedra y sistema de sujeción de la pantalla con imanes.

Bombilla recomendada: E-27 7W o 11W LED (no incluida).

Importante: la longitud del cable estándar es de 1 metro, si se desea una medida especial póngase en contacto con nosotros. Se puede valorar cambio en el color de la madera para proyectos con un mínimo de unidades, no duden en consultarnos.



Suspension lamp
Lámpara de suspensión
Ref 6802 BL

LUCETA

2021 by Massmi

Luceta has a traditional and timeless style. A white cotton shade floating on the air and hold with three steel cables. Simply designed, can be used in different ambiances creating atmospheres with warm and envolving light to illuminate directly.

Luceta es de estilo tradicional y atemporal. Una lámpara de suspensión con pantalla de algodón blanco que flota en el aire sujeta con tres tensores. Su diseño sencillo permite que pueda ser utilizada en diferentes tipos de ambientes. Consigue crear una atmósfera de luz cálida y envolvente que ilumina directamente.



MASSMI

SINCE 1942

Suspension lamp
Lámpara de suspensión
Ref 6500

Suspension lamp / Lámpara de suspensión

Ref 6500

LED 2 x 11W **A+**

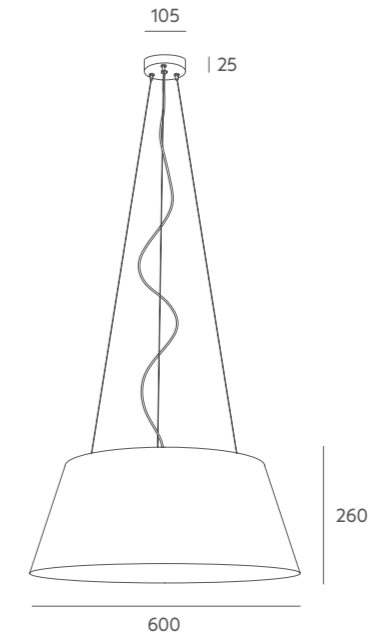

Tecnical data

Frame: satin nickel canopy.

Details: traslucent cotton shade with white parchment diffuser. Steel cable + transparent PVC cable.

Recommended Bulb: E-27 11W LED (not included).

Important: the standard cable length is 1 metre, if you need special size please contact our Customer Support Department.

Finishes Acabados

Shade / Pantalla



BL

Metal Colour / Acabado Metal



NI

Información técnica

Cuerpo: florón níquel satinado.

Detalles: pantalla algodón traslúcido con difusor de pergamino blanco. Cable de acero + cable PVC transparente.

Bombilla recomendada: E-27 11W LED (no incluida).

Importante: la longitud del cable estándar es de 1 metro, si desea una medida especial no dude en ponerse en contacto con nosotros.



VERSUS

2012 by Massmi

Versus was initially designed as a ceiling lamp for spaces that require an extra-large lighting fixture. The handmade shade is made of silk ribbon and comes in five colors. Even when switched off, Versus is an attractive fixture; switched on it emanates a nuanced light.

Inicialmente creamos una lámpara de suspensión pensada para proyectos que requieran dimensiones XXL, así nació Versus. Su pantalla de cinta de seda colocada artesanalmente está disponible en cinco colores. Apagada posee una atractiva presencia y encendida propaga una luz rica en matices.



Silk ribbon shade detail
Detalle pantalla cinta de seda



Suspension lamp
Lámpara de suspensión
Ref 6937- 80 VE

Suspension lamps / Lámparas de suspensión

Ref 6937-80/100

LED 5 x 11W **A+**



Ref 6937-60

LED 3 x 11W **A+**



Table lamp / Lámpara de mesa

Ref 4400

LED 1 x 7W **A+**



Tecnical data

Frame: painted or coated iron metal.

Details: silk ribbon shade without diffuser. Structure with silk ribbon volume. Special support for pendant lamp shades. Wire according to metal colour. Suspension lamp Ø 600 textile cable. Table lamp transparent or black PVC cable. For Ø 800 and Ø 1000 pendant, steel cable is used.

Recommended Bulb: E-27 7W or 11W LED (not included).

Important: the standard cable length is 1 metre, if you need special size please contact our Customer Support Department.

Información técnica

Cuerpo: metal hierro pintado o bañado.

Detalles: pantalla seda encintada sin difusor. Estructura con volumen encintada. Cogidas de la pantalla especiales en suspensión. Cable según versión. Lámpara de suspensión Ø 600 cable textil. Lámpara de mesa cable PVC transparente o negro. Montura de suspensión Ø 800 y Ø 1000 con cable de acero.

Bombilla recomendada: E-27 7W o 11W LED (no incluida).

Importante: la longitud del cable estándar es de 1 metro, si desea una medida especial no dude en ponerse en contacto con nosotros.

Finishes Acabados

Shade / Pantalla



BL CR GR NE VE

Metal Colour / Acabado Metal

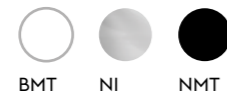

BMT NI NMT

Cable / Cable

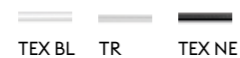

TEX BL TR TEX NE



Table lamp
Lámpara de mesa
Ref 4400 NMT GR

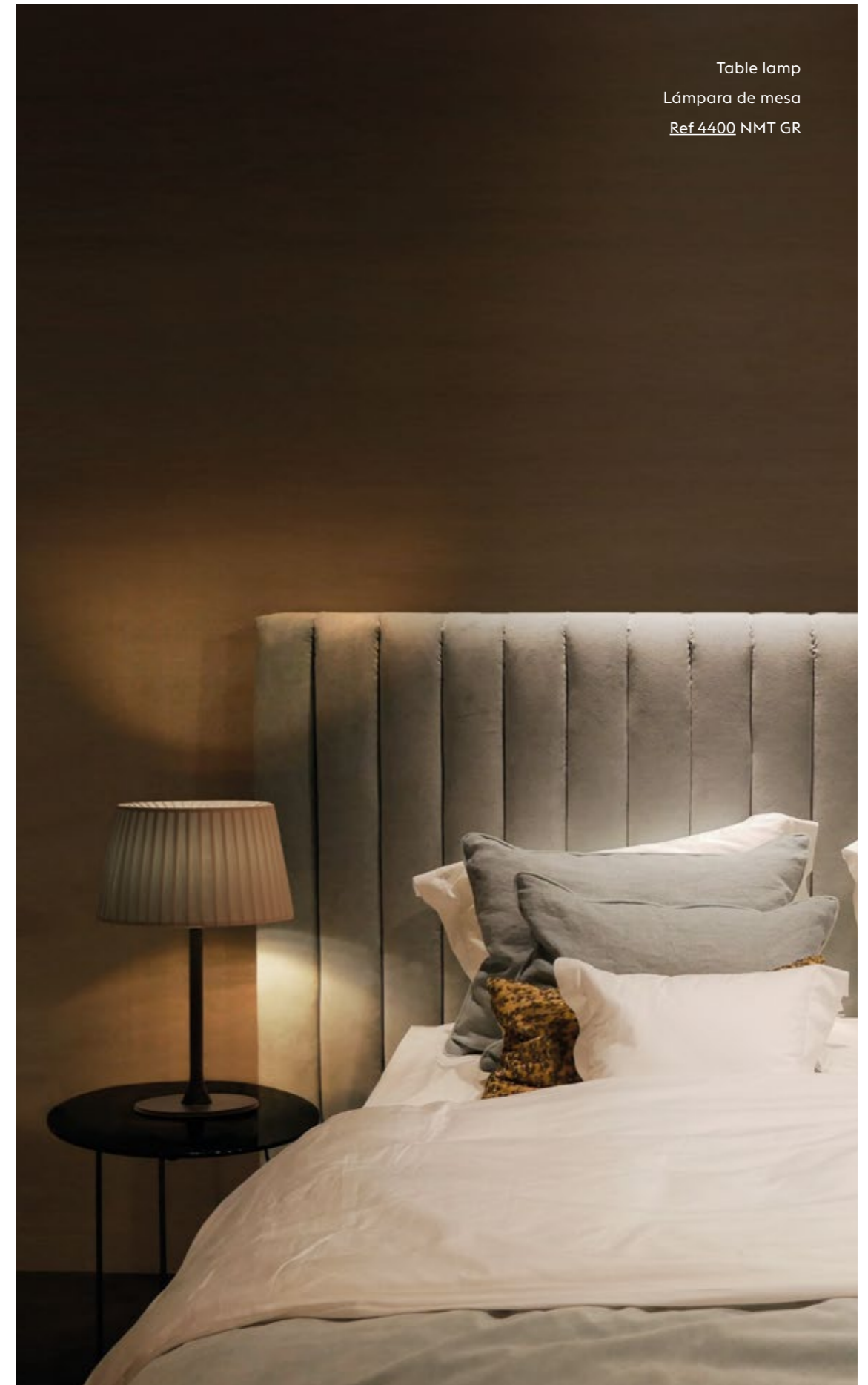

ECLIPSE

2021 by Massmi

This collection of wall lamps simulates the intersection between light and shape, it reminds us the eclipse phenomenon. Decorative, round shaped, two versions with and without brim, variety of sizes to create wonderful combinations. It is versatile to be used in Contract and private settings, the diffused light obtained make warm and cosy ambiances.

Colección de apliques que simula la intersección de luz y forma, nos recuerda al fenómeno del eclipse. De carácter decorativo con forma circular que gracias a sus dos versiones, con y sin ala y a la variedad de tamaños permite crear maravillosas combinaciones. Su versatilidad hace que este modelo pueda incorporarse tanto en proyectos de ámbito residencial como en proyectos relacionados con el contract. Emite una luz difusa que genera espacios cálidos y acogedores.



Ceiling lamp & wall lamps
Plafones y lámparas de pared
Ref 3504-50 BL / AZ
Ref 3504-70 BL



Ceiling lamp & wall lamps
Plafones y lámparas de pared
[Ref 3504-70 BL](#)
[Ref 3504-50 BL](#)



Ceiling lamp & wall lamps
Plafones y lámparas de pared
[Ref 3506-40 BL / AZ](#)
[Ref 3506-25 BL / AZ](#)



Ceiling lamp & wall lamps
Plafones y lámparas de pared
Ref.3504-50 MA

Plafond & wall lamp / Plafón y lámpara de pared

Ref 3504-70

LED 2 x 11W **A+**

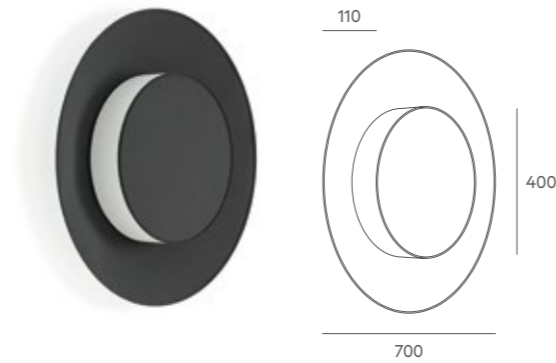

Ref 3504-50

LED 2 x 7W **A+**

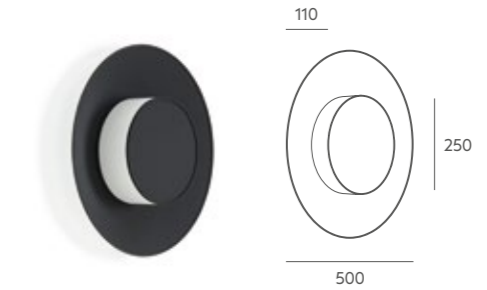

Ref 3506-40

LED 2 x 11W **A+**



Ref 3506-25

LED 2 x 7W **A+**



Tecnical data

Details: opaque cotton lampshade. Side white parchment diffuser. Stone sockets and magnet system to hang the shade.

Recommended bulb: E-27 7W or 11W LED (not included).

Important: we can evaluate to change lampshade material for projects with a minimum quantity of pieces, please check with us.

Shade / Pantalla



Información técnica

Detalles: pantalla de tela algodón opaco. Difusor lateral de pergamino blanco. Portalámparas de piedra y sistema de sujeción de la pantalla con imanes.

Bombilla recomendada: E-27 7W o 11W LED (no incluida).

Importante: se puede valorar cambios de tela para proyectos con un mínimo de unidades, no duden en consultarnos.



VOLUM OPAQUE

2011 by Massmi

Volum is perfect flushmount lamp for home or office. By combining two or more ceiling lamps with its simple magnet system, clients can create their own compositions that go beyond the traditional look these types of lamps traditionally have. Available in black or white opaque cotton and five shapes, one of them with three sizes. The option with gold inside has been incorporated. The combinations are endless and the result is always spectacular.

Volum es una luminaria de techo tanto para el hogar como el Contract que, combinando dos o más plafones y con su sistema imantado, crea una composición que va más allá de las formas tradicionales en este tipo de luminarias. Está disponible en dos colores: algodón opaco blanco o negro y cinco formatos, uno de ellos con tres medidas. Se ha incorporado la opción con el interior dorado. Las combinaciones son infinitas y el resultado, siempre espectacular.

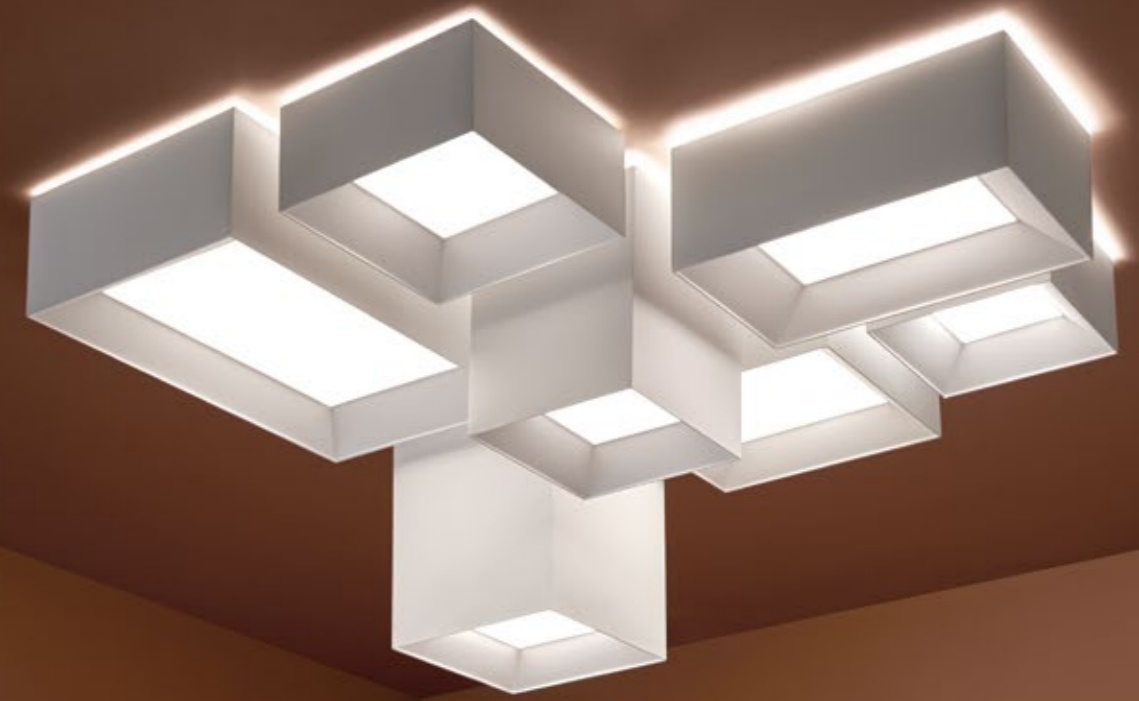

Example composition / Ejemplo composición
Ref 3485-35-BL + Ref 3485-40 BL + Ref 3485-50 BL
Ref 3498 BL + Ref 3499 BL + Ref 3484 BL + Ref 3483 BL



Example composition / Ejemplo composición
Ref 3485-40 BL + Ref 3485-50 BL + Ref 3483 BL

A



B



Example composition A / Ejemplo composición A
[Ref 3497-50 NE](#) + [Ref 3500 NE](#) + [Ref 3495 NE](#)

Example composition B / Ejemplo composición B
[Ref 3497-50 BL](#) + [Ref 3501 BL](#) + [Ref 3495 BL](#) + [Ref 3496 BL](#)

Ceiling lamps / Plafones

Ref 3485-35 BL / NE

Ref 3497-35 BL-D / NE-D *
* Golden interior / Interior dorado

LED 2 x 11W **A+**

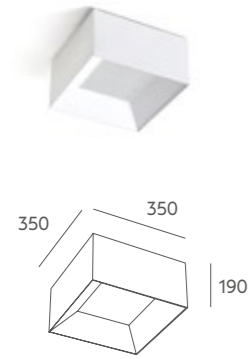

Ref 3498 BL/NE

Ref 3500 BL-D /NE-D *
* Golden interior / Interior dorado

LED 2 x 11W **A+**

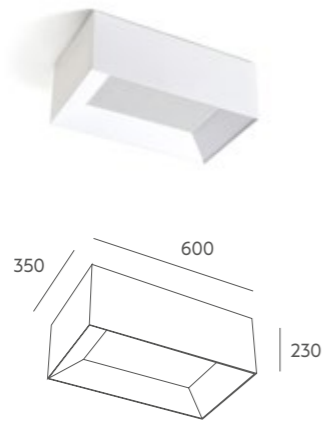

Ref 3485-40 BL / NE

Ref 3497-40 BL-D / NE-D *
* Golden interior / Interior dorado

LED 2 x 11W **A+**

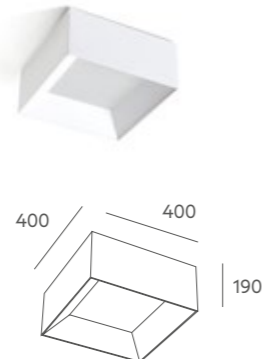

Ref 3499 BL/NE

Ref 3501 BL-D /NE-D *
* Golden interior / Interior dorado

LED 4 x 11W **A+**

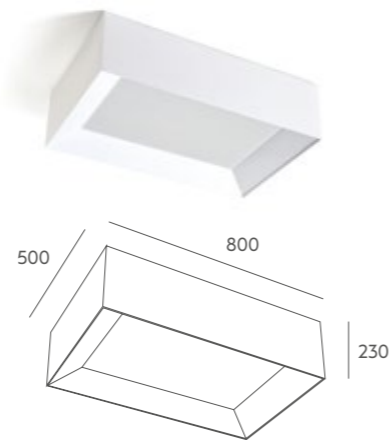

Ref 3485-50 BL / NE

Ref 3497-50 BL-D / NE-D *
* Golden interior / Interior dorado

LED 4 x 11W **A+**

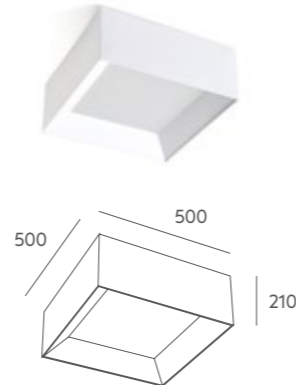

Ref 3484 BL / NE

Ref 3496 BL-D /NE-D *
* Golden interior / Interior dorado

LED 3 x 11W **A+**

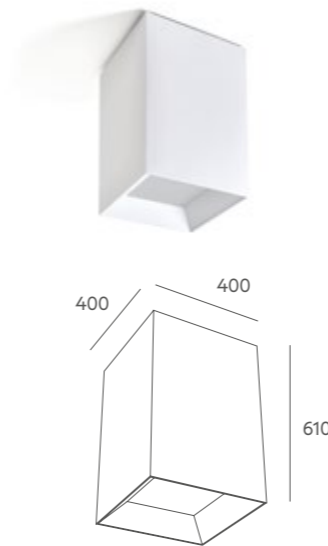

Ref 3483 BL / NE

Ref 3495 BL-D /NE-D *
* Golden interior / Interior dorado

LED 2 x 11W **A+**

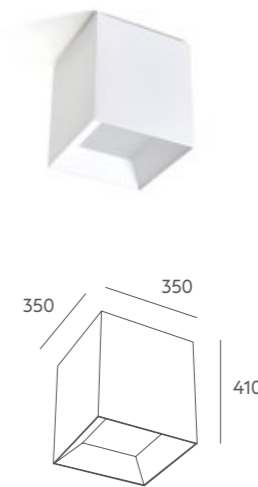

Example composition A / Ejemplo composición A

Ref 3483 + Ref 3484 + Ref 3485-35 BL / NE

Ref 3495 + Ref 3496 + Ref 3497-35 BL-D / NE-D *
* Golden interior / Interior dorado



Example composition B / Ejemplo composición B

Ref 3483 + Ref 3484 + Ref 3485-50 + Ref 3499 BL / NE

Ref 3495 + Ref 3496 + Ref 3497-50 + Ref 3501 BL-D / NE-D *
* Golden interior / Interior dorado

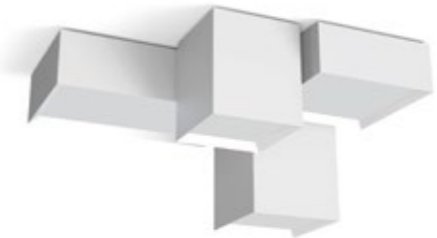

Example composition C / Ejemplo composición C

Ref 3484 + Ref 3485-50 + Ref 3499 + Ref 3498

+ Ref 3485-40 BL / NE

Ref 3496 + Ref 3497-50 + Ref 3501 + Ref 3500

+ Ref 3497-40 BL-D / NE-D * * Golden interior / Interior dorado

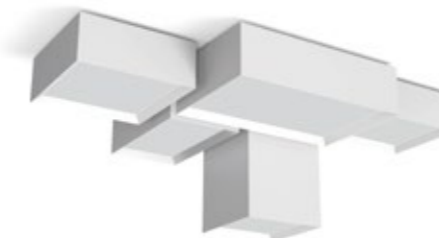

Example composition D / Ejemplo composición D

Ref 3483 + Ref 3484 + Ref 3498 + Ref 3499 + Ref 3485-35

+ Ref 3485-50 BL / NE

Ref 3495 + Ref 3496 + Ref 3500 + Ref 3501 + Ref 3497-35

+ Ref 3497-50 BL-D / NE-D * * Golden interior / Interior dorado



Tecnichal data

Details: opaque cotton lampshade. White parchment diffuser. Stone socket. Magnet system.

Recommended bulb: E-27 11W LED (not included).

Important: we can evaluate to change lampshade material for projects with a minimum quantity of pieces, please check with us.

Información técnica

Detalles: pantalla tela algodón opaco. Difusor de pergamino blanco. Portalámparas de piedra. Sistema de sujeción de la pantalla con imanes.

Bombilla recomendada: E-27 11W LED (no incluida).

Importante: se puede valorar cambios de tela para proyectos con un mínimo de unidades, no duden en consultarnos.

Finishes Acabados

Shade / Pantalla



VOLUM TRANSLUCENT

2011 by Massmi

Volum ceiling lamps fit perfectly in both private and contract projects. By combining different lamps of this collection we can create several compositions. Available in different translucent colors allowing light to pass through.

Los plafones Volum se integran a la perfección tanto en espacios residenciales como en proyectos contract. Permite crear composiciones muy diversas combinando las diferentes opciones de esta colección. Disponible en diferentes colores de traslúcidos, lo que favorece al paso de la luz.



Ceiling lamp
Plafón
Ref 3488-40 NE



Ceiling lamps / Plafones

Ref 3488-35

LED 2 x 11W **A+**

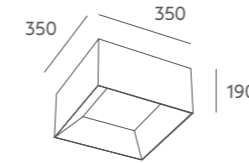

Ref 3488-40

LED 2 x 11W **A+**

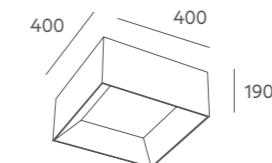

Ref 3488-50

LED 4 x 11W **A+**

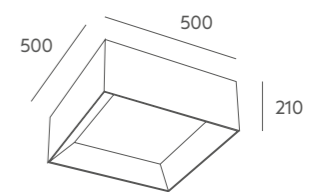

Example composition A / Ejemplo composición A

Ref 3488-35 x 4 GR



Example composition B / Ejemplo composición B

Ref 3488-40 x 2 + Ref 3488-50 MA



Ceiling lamps
Plafones

Ref 3488-35 GR

Ref 3488-50 AZ

Tecnical data

Details: translucent cotton lampshade. White parchment diffuser. Stone socket. Magnet system.

Recommended bulb: E-27 11W LED (not included).

Important: we can evaluate to change lampshade material for projects with a minimum quantity of pieces, please check with us.

Shade / Pantalla



Información técnica

Detalles: pantalla tela algodón traslúcido. Difusor de pergamino blanco. Portalámparas de piedra. Sistema de sujeción de la pantalla con imanes.

Bombilla recomendada: E-27 11W LED (no incluida).

Importante: se puede valorar cambios de tela para proyectos con un mínimo de unidades, no duden en consultarnos.



IN OPAQUE

2010 by Massmi

The word "In" reflects the main feature of this lamp, namely the slightly concave shape of the diffuser to give a "lucernario" or skylight effect. Collection of suspensions and ceiling lamps in different sizes. Its beauty lies in its simplicity and practicality with its magnet system. By combining different models we can create compositions in different heights and/or colors.

Su nombre "In" ya subraya su principal característica formal, el leve retranqueo interior del difusor buscando un efecto lucernario, además de ofrecer así una alternativa a este tipo de luminarias. Colección compuesta de plafones de techo y colgantes en distintos tamaños. Encuentra su atractivo en la simplicidad y nitidez, y su practicidad en las versiones de plafón de techo con sistema imantado. Permite combinar modelos y generar de esta manera composiciones de diversas alturas y/o colores.

MASSMI



Ceiling lamp
Plafones
Ref 3478-40 BL
Ref 3478-50 BL



Suspension lamps
Lámparas de suspensión
Ref 6942-50 CR Ref 6942-70 D

SINCE 1942

[Ref 3494-40 NE-D](#) + [Ref 3494-50 NE-D](#) + [Ref 3509 NE-D](#)



[Ref 3509 BL-D](#) + [Ref 3494-50 BL-D](#)

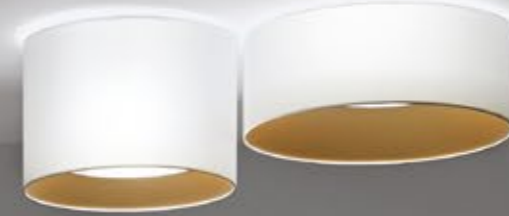

[Ref 3494-70 BL-D](#)



Suspension lamps / Lámparas de suspensión

Ref 6925-70 BL / NE

Ref 6942-70 BL-D / CR-D / D / NE-D *

* Golden interior / Interior dorado

LED 3 x 11W  

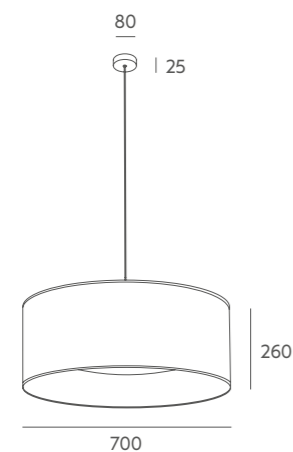

Ref 6925-50 BL / NE

Ref 6942-50 BL-D / CR-D / D / NE-D *

* Golden interior / Interior dorado

LED 2 x 11W  

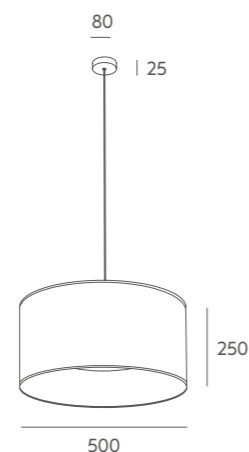

Tecnical data

Details: opaque cotton shade. White parchment diffuser. Ceiling lamp with stone sockets and magnet system to hang the shade. Golden outside option has beige inside.

Recommended bulb: E-27 11W LED (not included).

Important: the standard cable length is 1 metre, if you need special size please contact our Customer Support Department. We can evaluate to change lampshade material for projects with a minimum quantity of pieces, please check with us.

Información técnica

Detalles: pantalla tela algodón opaco. Difusor de pergamino blanco. Versión plafón,portalámparas de piedra y sistema de sujeción de la pantalla con imanes. Opción exterior dorado siempre lleva el interior crema.

Bombilla recomendada: E-27 11W LED (no incluida).

Importante: la longitud del cable estándar es de 1 metro, si desea una medida especial no dude en ponerse en contacto con nosotros. Se puede valorar cambios de tela para proyectos con un mínimo de unidades, no duden en consultarnos.

Finishes Acabados

Shade / Pantalla



Metal Colour / Acabado Metal

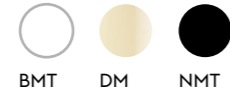

Cable / Cable



Ceiling lamps / Plafones

Ref 3478-40 BL / NE

Ref 3494-40 BL-D / CR-D / D / NE-D *

* Golden interior / Interior dorado

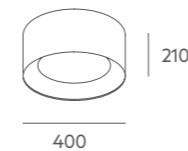

LED 2 x 11W  



Ref 3507 BL / NE

Ref 3509 BL-D / CR-D / NE-D *

* Golden interior / Interior dorado

LED 2 x 11W  

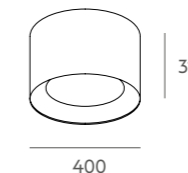

Ref 3508 BL / NE

Ref 3510 BL-D / CR-D / NE-D *

* Golden interior / Interior dorado

LED 2 x 11W  

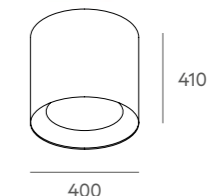

Ref 3478-50 BL / NE

Ref 3494-50 BL-D / CR-D / D / NE-D *

* Golden interior / Interior dorado

LED 2 x 11W  

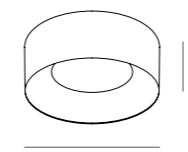

Ref 3478-70 BL / NE

Ref 3494-70 BL-D / CR-D / D / NE-D *

* Golden interior / Interior dorado

LED 4 x 11W  

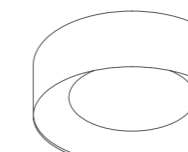

Ref 3478-100 BL / NE

Ref 3494-100 BL-D / CR-D / NE-D *

* Golden interior / Interior dorado

LED 6 x 11W  

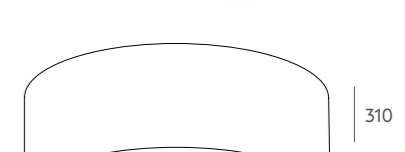

Example composition A / Ejemplo composición A

Ref 3478-40 x 2 BL + Ref 3507 BL + Ref 3508 BL



Example composition B / Ejemplo composición B

Ref 3508 BL + Ref 3478-50 BL + 3478-70 BL



IN TRANSLUCENT

2010 by Massmi

Used as a general piece of illumination in different kind of projects. The variety of versions allows to create several compositions. In this case, the translucent material used creates open ambiances.

Empleada como pieza de iluminación general en diversos tipos de proyectos y que, por la variedad de versiones en las que se presenta, permite crear numerosas composiciones. Este modelo, por el material traslúcido de la pantalla, permite el paso de la luz a través de ella generando ambientes diáfanos.



Ceiling lamp
Plafón
Ref 3477-100 BL



Suspension lamp
Lámpara de suspensión
Ref 6941-50 PC



Ceiling lamps
Plafones
Ref 3477-40 MA
Ref 3477-70 MA

Suspension lamps / Lámparas de Suspensión

Ref 6941-50-70 Pleated / Plisado

LED 2-3 x 11W A+

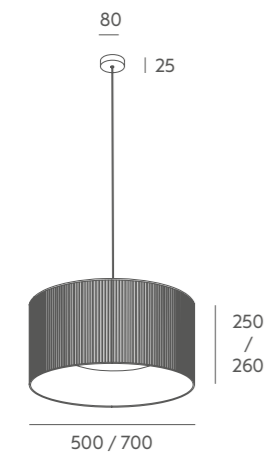

Ref 6924-50 Cotton / Algodón

LED 2x 11W A+

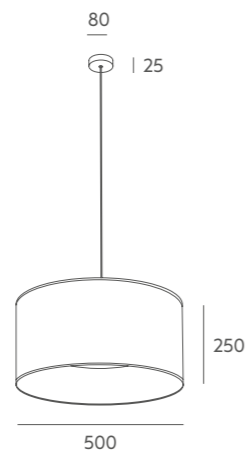

Ref 6924-70 Cotton / Algodón

LED 3 x 11W A+

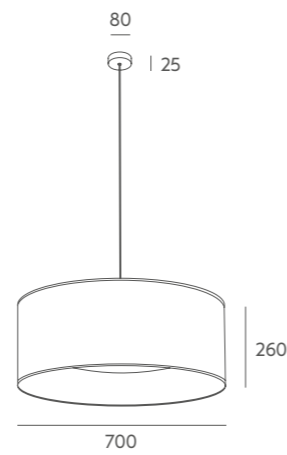

Tecnical data

Details: pleated or not cotton shade. White parchment diffuser. Suspension lamp, textil cable Ref 6924, PVC cable Ref 6941. Ceiling lamp with stone sockets and magnet system to hang the shade. Option with pleated outside has beige inside.

Recommended bulb: E-27 11W LED (not included).

Important: the standard cable length is 1 metre, if you need special size please contact our Customer Support Department. We can evaluate to change lampshade material for projects with a minimum quantity of pieces, please check with us.

Información técnica

Detalles: pantalla tela algodón liso o plisado traslúcido. Difusor de pergamino blanco. Lámpara de suspensión, cable textil Ref 6924, cable PVC Ref 6941. Plafón, portalámparas de piedra y sistema de sujeción de la pantalla con imanes. Opción exterior plisado siempre lleva el interior crema.

Bombilla recomendada: E-27 11W LED (no incluida).

Importante: la longitud del cable estándar es de 1 metro, si desea una medida especial no dude en ponerse en contacto con nosotros. Se puede valorar cambios de tela para proyectos con un mínimo de unidades, no duden en consultarnos.

Finishes Acabados

Shade / Pantalla



Metal Colour / Acabado Metal

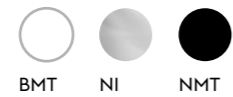

Cable / Cable

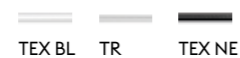

Ceiling lamps / Plafones

Ref 3477-40 Cotton / Algodón

LED 2 x 11W A+

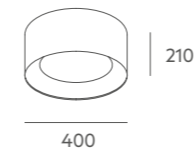

Ref 3477-50 Cotton / Algodón

LED 2 x 11W A+

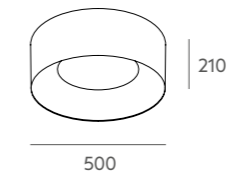

Ref 3477-70 Cotton / Algodón

LED 4 x 11W A+

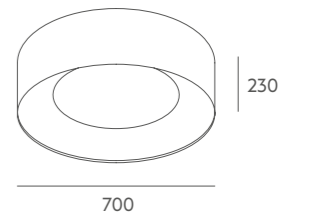

Ref 3477-100 Cotton / Algodón

LED 6 x 11W A+

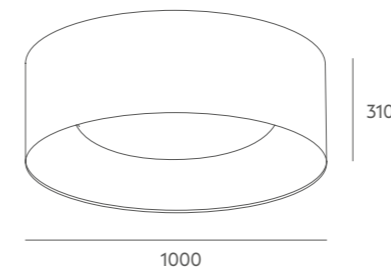

Ref 3493-40-50-70 Pleated / Plisado

LED Ø 40-50, 2 x 11W

LED Ø 70, 4 x 11W A+

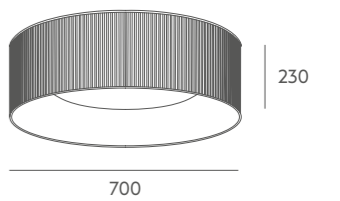
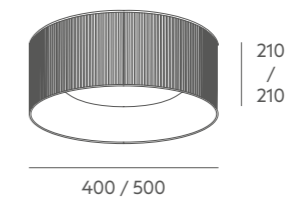

Example composition A / Ejemplo composición A

Ref 3477-40 AZ + Ref 3477-70 AZ



Example composition B / Ejemplo composición B

Ref 3477-40 MA + Ref 3477-50 AZ + Ref 3477-70 MA

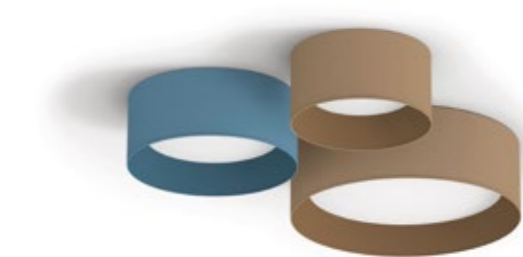

HANG OUT

2007 by Massmi

Hang Out gives a vertical look to any space, with its illusion of solidity even as it hangs in the air. The shade has an embedded system for adjusting the height of the lamp. You can choose between a ceiling connection or a plug connection to add warmth and light to any cosy nook.

Hang Out impone verticalidad jugando entre una rotunda solidez y la ingravidez imaginaria. La pantalla incorpora en su interior un mecanismo que permite graduar su altura y es posible instalarla a techo o bien encenderla en un rincón especial, genera una luz intimista y confortable en el espacio.



MASSMI

Suspension lamp
Lámpara de suspensión
[Ref 6846 C BL BMT](#)



Suspension lamps
Lámparas de suspensión
[Ref 6846 C NE NMT](#)

[Ref 6846 C AZ BMT](#)

[Ref 6846 C BL BMT](#)

SINCE 1942

Suspension lamp / Lámpara de suspensión

Ref 6845 C / S · Pleated / Plisado C = A plug / A enchufe S = To ceiling / A techo

Ref 6846 C / S · Cotton / Algodón

LED 2 x 11W **A+**

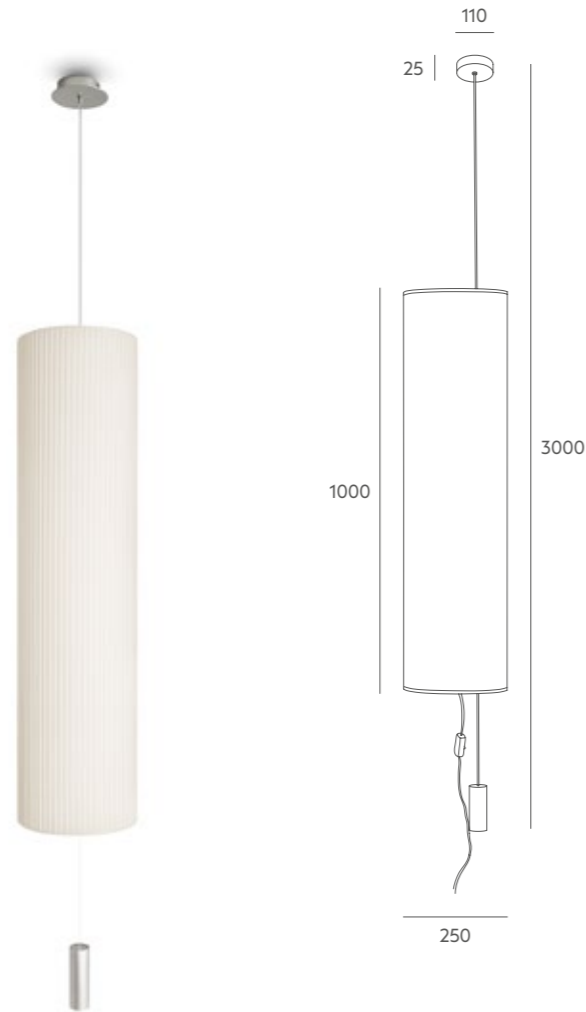

Tecnical data

Frame: painted iron metal or satin nickel for canopy and counterweight.

Details: translucent cotton shade or beige pleated. Up and down lighting fixture with interior mechanism and sliding steel wire. Black or transparent PVC cable.

Recommended Bulb: E-27 11W LED (not included).

Important: the standard cable length is 3 metres, if you need special size please contact our Customer Support Department.

Información técnica

Cuerpo: metal hierro pintado o níquel satinado en contrapeso y florón.

Detalles: pantalla algodón traslúcido o plisada crema. La lámpara sube y baja a través de un mecanismo interior por el que desliza el acero. Cable PVC negro o transparente.

Bombilla recomendada: E-27 11W LED (no incluida).

Importante: la longitud del cable estándar es de 3 metros, si desea una medida especial no dude en ponerse en contacto con nosotros.

Finishes Acabados

Shade / Pantalla



AZ BL PC NE

Metal Colour / Acabado Metal



BMT NI NMT

Cable / Cable

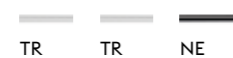

TR TR NE



Suspension lamps

Lámpara de suspensión

Ref 6845 C PC NI

ZESTA

2019 by Aranda Aloy Enblanc

Shows the simplicity of a metallic geometry holded to a sphere of light.
Used as wall lamp or ceiling lamp, can be installed at 360° from the base,
so the light will be the only protagonist.

Establece la simplicidad de una geometría metálica que abraza a una
esfera de luz. Un aplique de pared o techo que, pudiéndose instalar desde
su base a 360°, permite que la luz sea la única protagonista.



[Ref 1707-1](#) BMT / AZ / NMT / TE

Ceiling lamps & wall lamps
Plafones y lámparas de pared
[Ref 1707-2](#) BMT / NMT / TE

Wall lamp
Lámpara de pared
Ref.1707-1 BMT



Ceiling lamp & wall lamp / Plafón y lámpara de pared

Ref.1707-2

LED 2 x G9 4W **A+**



Ref.1707-1

LED 1 x G9 4W **A+**

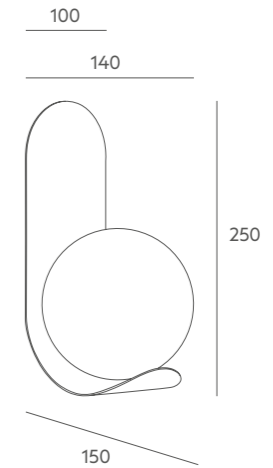
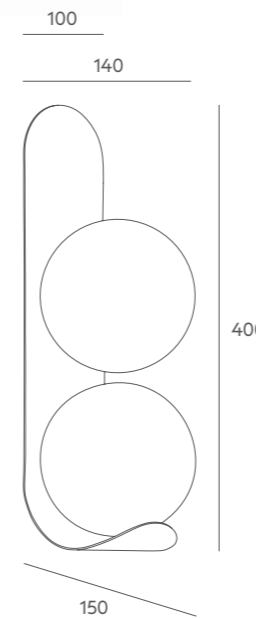

Tecnical data

Frame: painted curved iron metal.

Details: opal mate glasses fixed by clip Ø 140 mm.

Recommended Bulb: G9 4W 3000K. 400 Lm 36° LED (included).

Important: can be installed in any position, ceiling and wall. We can evaluate to change painting colour for projects with a minimum quantity of pieces, please check with us.

Información técnica

Cuerpo: metal hierro curvado pintado.

Detalles: tulipas opal mate cogida con pinzas Ø 140 mm.

Bombilla recomendada: G9 4W 3000K. 400 Lm 36° LED (incluida).

Importante: puede colocarse en cualquier posición, tanto a techo como a pared. Se puede valorar cambios de color de pintura para proyectos con un mínimo de unidades, no duden en consultarnos.

Finishes Acabados

Metal Colour / Acabado Metal



Glass / Cristal



INFINITO

2003 by Massmi

Infinito is a timeless classic that combines form and function in its angular presentation. Versatile and elegant, Infinito is the perfect fixture for those seeking a warm light to enhance any setting.

Un clásico atemporal. Pieza angular de interioristas, Infinito aún sobriedad formal y funcional. Versátil y elegante gran aliada de quien guste una iluminación cálida y confortable.

MASSMI



Table lamp
Lámpara de pie
Ref 4250 NMT NE

Table lamp
Lámpara de mesa
Ref 4250 BMT BL

Floor lamp
Lámpara de pie
Ref 5250 BMT BL



SINCE 1942

Suspension lamp
Lámpara de suspensión
Ref 6808 NI PC



Suspension lamp / Lámpara de suspensión

Ref 6808

LED 3 x 7W **A+**



Table lamps / Lámparas de mesa

Ref 4250

LED 2 x 7W **A+**



Floor lamp / Lámpara de pie

Ref 5250

LED 3 x 7W **A+**



Ref 4248

LED 2 x 7W **A+**

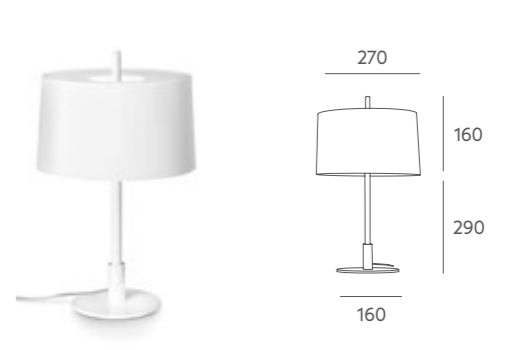

Tecnical data

Frame: painted or coated iron metal.

Details: translucent cotton shade. The pendant has glass diffuser. Table and floor lamps have top covers partial in same material. Complete collection has special support. Black or transparent PVC cable.

Recommended Bulb: E-27 7W LED (not included).

Important: the standard cable length is 1 metre, if you need special size please contact our Customer Support Department.

Finishes Acabados

Metal Colour / Acabado Metal

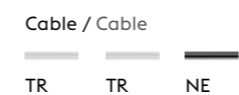
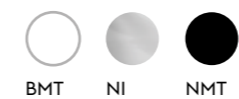

Shade / Pantalla



Información técnica

Cuerpo: metal hierro pintado o bañado.

Detalles: pantalla tela de algodón traslúcido. La suspensión lleva difusor de cristal. Las lámparas de mesa y suelo llevan tapas superiores parciales de la misma tela. Toda la familia tiene una cogida especial. Cable PVC negro o transparente.

Bombilla recomendada: E-27 7W LED (no incluida).

Importante: la longitud del cable estándar es de 1 metro, si desea una medida especial no dude en ponerse en contacto con nosotros.



LOULU

2001 by Massmi

Three metal tubes come together to make a teepee-like frame without the need for a solid base. Topped with an oversize lampshade available in two different materials, Loulu is an attractive lamp that goes anywhere, lending a fresh look to even the most somber space.

El triángulo que generan los tres tubos metálicos replicando la estructura de tienda de campaña india, sin necesidad de soporte en la base, junto con una generosa pantalla en dos opciones de material, proveen a Loulu de un atractivo visual y polifacético indiscutible, para crear una renovada atmósfera en espacios monótonos y asépticos.

MASSMI



Table Lamp
Lámpara de mesa
Ref 4370 BMT BL

- Table lamp
Lámpara de mesa
Ref 4137 NMT PC
- Floor lamp
Lámpara de pie
Ref 5370 BMT BL



SINCE 1942

Floor lamp / Lámpara de pie

Ref 5137 Pleated / Plisado Ref 5370 Cotton / Algodón

LED 3 x 11W **A+**



Table lamp / Lámpara de mesa

Ref 4137 Pleated / Plisada Ref 4370 Cotton / Algodón

LED 2 x 11W **A+**

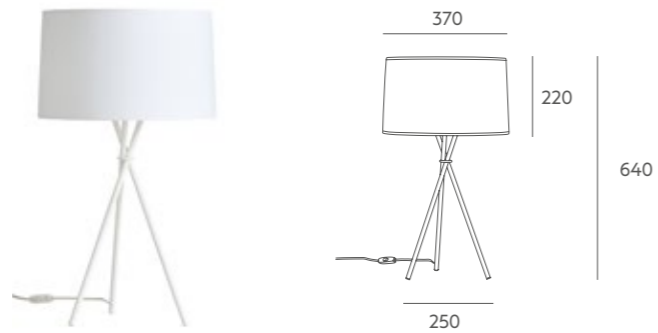

Tecnical data

Frame: painted iron metal.

Details: translucent cotton or pleated cotton [Ref 4137](#) [Ref 5137](#).
Black or transparent PVC cable.

Recommended Bulb: E-27 11W LED (not included).

Finishes Acabados

Metal Colour / Acabado Metal



Cable / Cable



Shade / Pantalla



Información técnica

Cuerpo: metal hierro pintado.

Detalles: pantalla de algodón o plisado traslúcidos [Ref 4137](#) [Ref 5137](#). Cable PVC negro o transparente.

Bombilla recomendada: E-27 11W LED (no incluida).



Floor lamp
Lámpara de pie
[Ref 5137](#) NMT PN

PEA

2018 by Nacho Timón

Simple and fashionable family of lighting with nice and minimal appearance. Several peas made of glass orbit around a metallic frame. With one or two lights, it is a perfect collection to make combinations in contract projects.

Modelo sencillo y de tendencia que presenta una familia de apariencia amable y minimalista. Varios guisantes de cristal que orbitan alrededor de un ligero marco metálico. Se presenta con una o dos luces, siendo una colección ideal combinando sus modelos en proyectos e instalaciones.

MASSMI



Wall lamp
Lámpara de pared
Ref 1401 CO

Suspension lamp
Lámpara de suspensión
Ref 6013-1 NMT

Ref 6013-2 D

Table lamp
Lámparas de mesa
Ref 4408 NMT

Ref 4407-1 D

Ref 4407-2 GR

SINCE 1942



Suspension lamp / Lámpara de suspensión

Ref 6013-2

LED 2 x G9 4W **A+**



Ref 6013-1

LED 1 x G9 4W **A+**

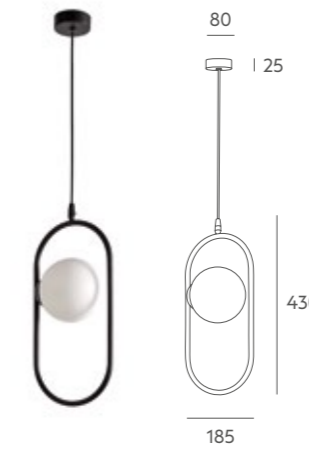

Wall lamp / Lámpara de pared

Ref 1401

LED 1 x G9 4W **A+**

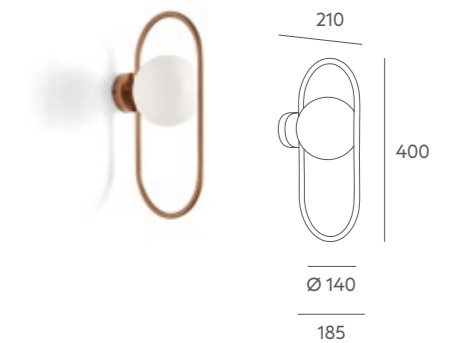
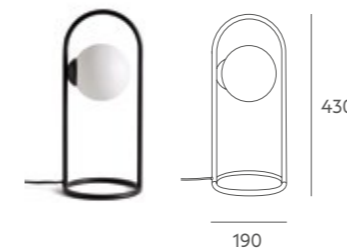

Table lamp / Lámpara de mesa

Ref 4408

LED 1 x G9 4W **A+**



Ref 4401-2

Ref 4407-2 Marble / Mármol

LED 2 x G9 4W **A+**



Ref 4401-1

Ref 4407-1 Marble / Mármol

LED 1 x G9 4W **A+**



Tecnical data

Frame: welded and painted iron metal.

Details: opal mate glasses fixed by clips Ø 140 mm. Black plastic cable. Two options of bases, made of iron or marble.

Recommended Bulb: G9 4W 3000K. 400 Lm 36° (included).

Importante: standard lenght of cable is 1 metre, if you need special lenght please contact us. We can evaluate to change colour for projects with a minimum quantity of pieces, please check with us.

Información técnica

Cuerpo: metal hierro soldado y pintado.

Detalles: tulipas opal mate cogida con pinzas Ø 140 mm. Cable negro PVC. Bases disponibles en mármol o hierro.

Bombilla recomendada: G9 4W 3000K. 400 Lm 36° (incluida).

Importante: la longitud del cable estándar es de 1 metro, si desea una medida especial no dude en ponerse en contacto con nosotros. Se puede valorar cambios de color para proyectos con un mínimo de unidades, no duden en consultarnos.

Finishes Acabados

Metal Colour / Acabado Metal



Glass / Cristal



Base / Base



Suspension lamp
Lámpara de suspensión
Ref 6013-1 NMT Ref 6013-2 D

FALGA

2021 by Fluzo Project

Inspired by the fern's capacity for movement, a mobile attachment point is generated in the lamp that adapts it to each space. Employing a simple gesture, the user can adjust the type of lighting needed for each moment.

Inspirada en la capacidad de movimiento del helecho, es un punto de unión móvil en la lámpara que lo adapta a cada espacio. Por medio de un sencillo gesto se permite al usuario acomodar el tipo de iluminación necesaria para cada momento.

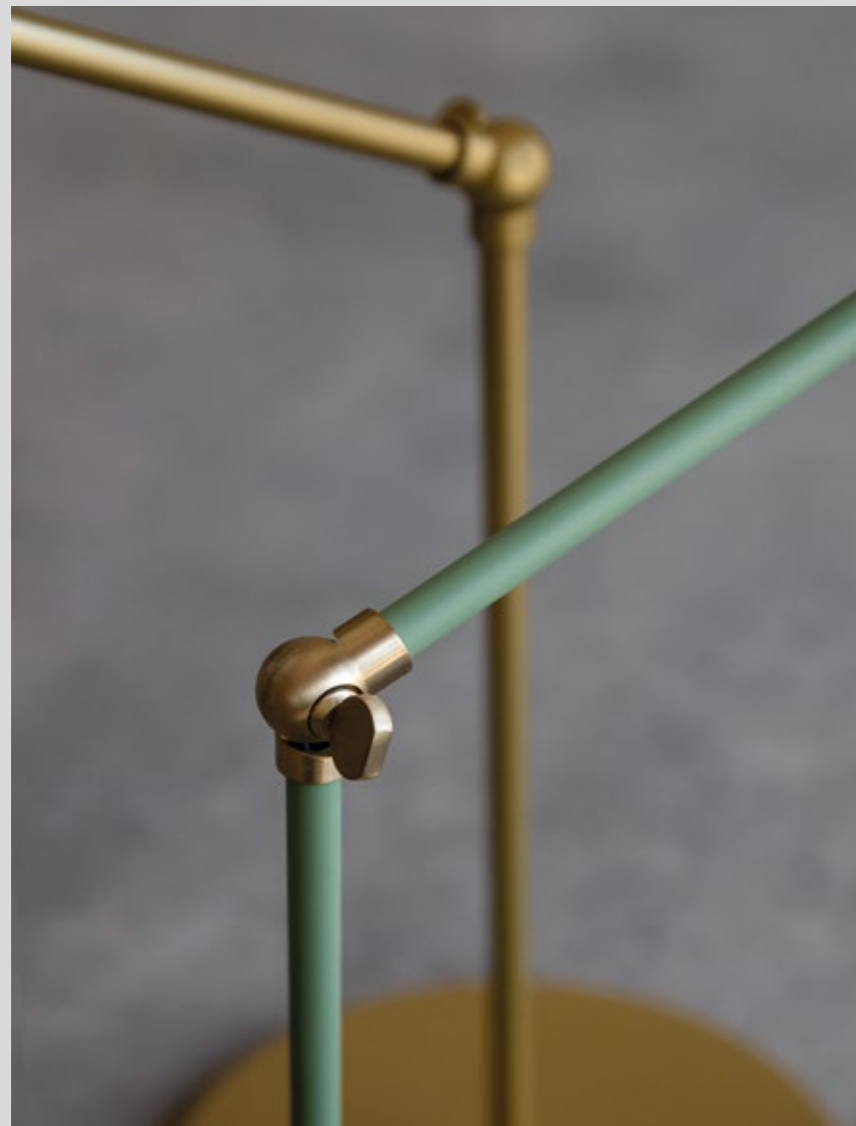

Golden kneecap
Rótula latonada

Table lamp
Lámpara de mesa
Ref 4437 NMT D





Floor lamp
Lámpara de pie
Ref 5437 NMT

Table lamp / Lámpara de mesa

Ref 4437

LED 1 x 7W **A+**

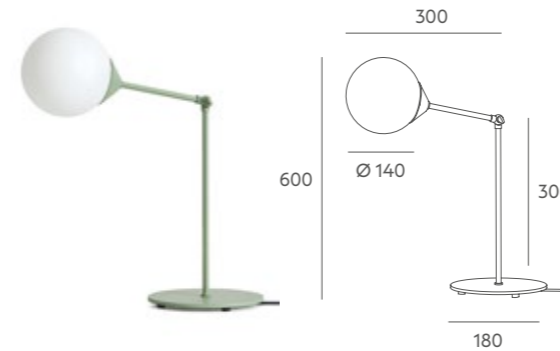

Ceiling lamp / Plafón

Ref 6437

LED 3 x 7W **A+**

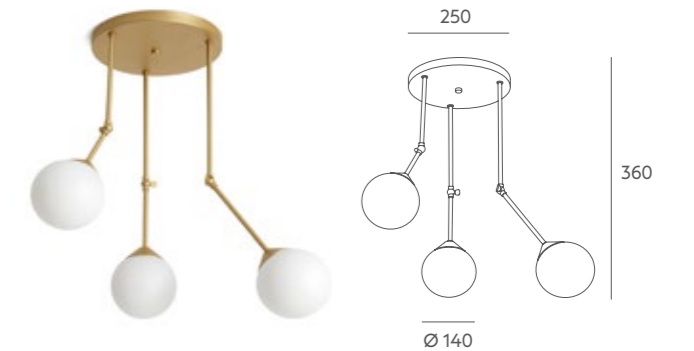

Floor lamp / Lámpara de pie

Ref 5437

LED 1 x 7W **A+**



Tecnical data

Frame: painted iron metal.

Details: opal mate glasses fixed by clip Ø 140 mm. Black PVC cable. Options NMT-D and VE-D have the golden kneecap.

Recommended Bulb: E-14 7W LED (not included).

Important: we can evaluate to change painting colour for projects with a minimum quantity of pieces, please check with us.

Finishes Acabados

Metal Colour / Acabado Metal



Glass / Cristal



Información técnica

Cuerpo: metal hierro pintado.

Detalles: tulipas opal mate cogida con pinzas Ø 140 mm. Cable PVC negro. Las opciones de color NMT-D y VE-D llevan rótula latonada.

Bombilla recomendada: E-14 7W LED (no incluida).

Importante: se puede valorar cambios de color de pintura para proyectos con un mínimo de unidades, no duden en consultarnos.

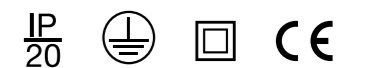

LLUNA

Reedition 1982

Sometimes the simplest things are the most durable. Lluna is inspired by a German ceiling lamp, the HL99, created in 1900. This design was an instant classic and during the Bauhaus movement, many versions of this lamp were created. LLuna carries on with this tradition, maintaining the prestige of this iconic sphere in the world of lighting decoration.

Muchas veces las cosas más simples son las más duraderas y memorables. Lluna está inspirada en una lámpara de techo alemana de 1900, la HL99. Durante ese período tanto en la Bauhaus como en otros movimientos artísticos contemporáneos, se diseñaron montones de esta versión. Así pues, con Lluna contribuimos a que la famosa "bola" continúe haciendo su magnífico papel en la iluminación de espacios contemporáneos.



Suspension lamp
Lámpara de suspensión
Ref 6880-40 NI

Ceiling lamp
Plafón
Ref 3420-20 VE

Table lamp
Lámpara de mesa
Ref 4239-20 VE / TE



Suspension lamps / Lámparas de suspensión

Ref 6880-40

LED 1 x 11W **A+**

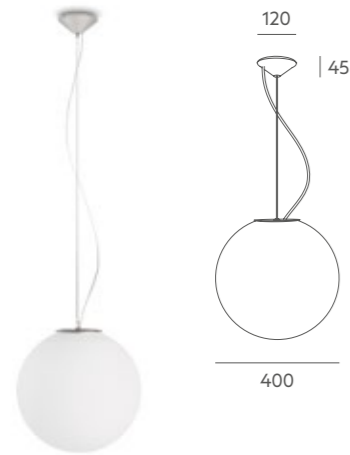

Ref 6880-35-30

LED 1 x 11W **A+**

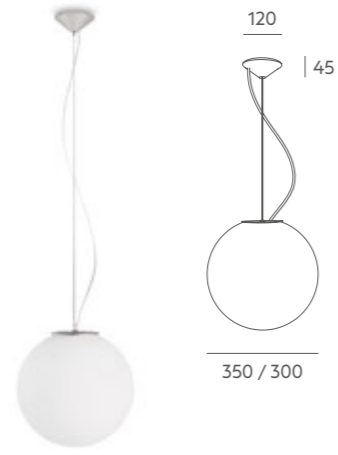

Ref 6880-25-20

LED 1 x 11W **A+**

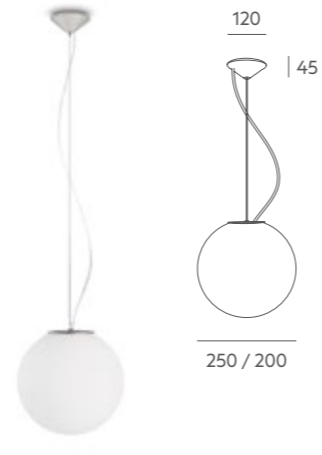

Ceiling lamp / Plafón

Ref 3420-20-30 *

* Ref 3420-20

Para aplique de pared sólo puede utilizarse Ref 3420-20

LED 1 x 11W **A+**

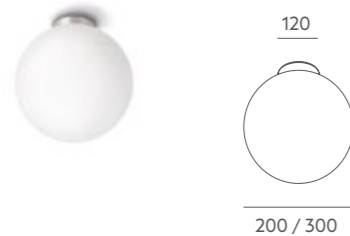

Table Lamp / Lámpara de mesa

Ref 4239-20-30

LED 1 x 11W **A+**



Tecnical data

Frame: satin nickel, satin brass colour or painted iron metal.

Details: opal mate glasses fixed by nuts (hanging lamp). By clips (plafond and table lamp). Table lamp transparent PVC cable. Suspension lamp Steel cable + transparent PVC cable.

Recommended Bulb: E-27 11W LED (not included).

Important: standard length of cable is 1 metre, if you need special length please contact us. We can evaluate to change coating or painting colour for projects with a minimum quantity of pieces, please check with us.

Información técnica

Cuerpo: metal hierro acabado níquel satinado, latón satinado o pintado en colores.

Detalles: tulipas opal mate. Cogida con tornillos (suspensión). Pinzas (plafón y mesa). Lámpara de mesa cable PVC transparente. Lámpara de suspensión cable acero + transparente PVC.

Bombilla recomendada: E-27 11W LED (no incluida).

Importante: la longitud del cable estándar es de 1 metro, si se desea una medida especial póngase en contacto con nosotros. Se puede valorar cambios en color de baño o pintura para proyectos con un mínimo de unidades, no duden en consultarnos.

Finishes Acabados

Metal Colour / Acabado Metal



Glass / Cristal



Suspension lamp
Lámpara de suspensión
Ref 6880-40 AZ

MOON

Design 1950

Moon is a remake of a lamp created by the German Bauhaus school in 1900. A seductive white sphere, this lamp enhances any space. Although it has been included in the Massmi catalogue for several decades. The sphere comes in seven sizes and the bar can be cut to measure in order to facilitate different compositions and accommodate various space requirements.

Moon es la actualización de una pieza creada por la escuela alemana Bauhaus en 1900. Una esfera blanca que, sitúes donde la sitúes, seduce. Massmi la fabrica desde hace décadas. Se presenta en siete tamaños de esfera y es posible personalizar el largo de la tiza lo que permite crear composiciones y adaptarla a cualquier requerimiento espacial.



MASSMI

Suspension lamp
Lámpara de suspensión
[Ref 6978-30 / 35 NMT](#)



SINCE 1942

Suspension lamps
Lámparas de suspensión
[Ref 6978- 20 / 25 / 30 /35 VE / AZ / BMT / TE](#)

Suspensión lamps / Lámparas de suspensión

Ref 6978-16

LED 1 x 11W **A+**

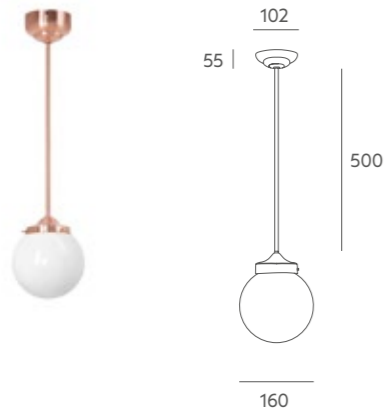

Ref 6978-18

LED 1 x 11W **A+**

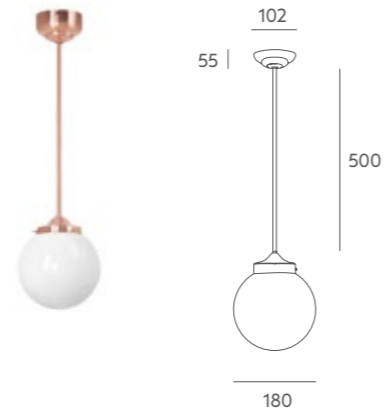

Ref 6978-35

LED 1 x 11W **A+**



Ref 6978-40

LED 1 x 11W **A+**



Ref 6978-20

LED 1 x 11W **A+**

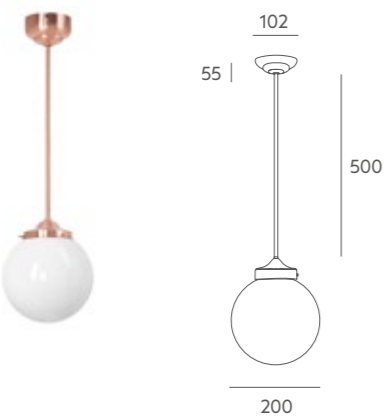

Ref 6978-25

LED 1 x 11W **A+**

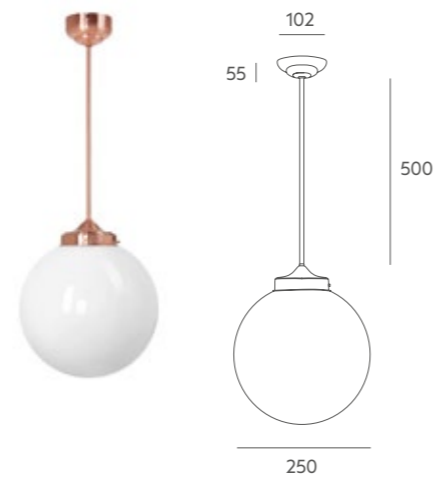

Ref 6978-30

LED 1 x 11W **A+**

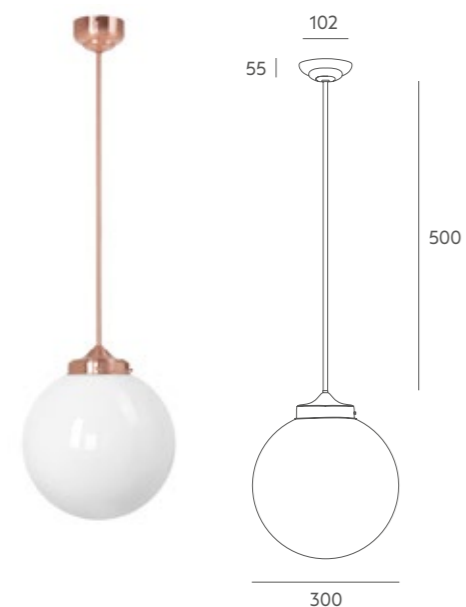

Tecnical data

Frame: painted or coated iron metal.

Details: opal triplex glasses fixed by nuts.

Recommended Bulb: E-27 11W LED (not included).

Important: standard metal bar is 50 cm, for special sizes contact us. We can evaluate to change coating or painting colour for project with a minimum quantity of pieces, please check with us.

Finishes Acabados

Metal Colour / Acabado Metal



Información técnica

Cuerpo: metal hierro pintado o bañado.

Detalles: cristal opal triplex brillo cogida con tornillos.

Bombilla recomendada: E-27 11W LED (no incluida).

Importante: tiza medida estándar de 50 cm. Para medidas especiales no duden en consultarnos. Se puede valorar cambios de color baño o pintura para proyectos con un mínimo de unidades, no duden en consultarnos.

Glass / Cristal





LAFFIE

2016 Restyling by Massmi

"Laffie" triumphs in settings that call for retro-style details. Functional yet fashionable, these lamps are extremely popular both in the decoration of private homes as well as in fashionable bars throughout the world.

Laffie triunfa en ambientes que requieren un detalle de estilo retro. Funcional y estéticamente a la última, las lámparas que conforman esta colección arrasan en la decoración de interiores particulares y también en los locales de moda de medio mundo.

MASSMI



Detail glasses
Detalle tulipas



Suspension lamps
Lámparas de suspensión
Ref 6001 TR
Ref 6000 MT

SINCE 1942



Suspension lamps
Lámparas de suspensión
Ref 6010-20 TR
Ref 6010-16 AM / AZ / TR

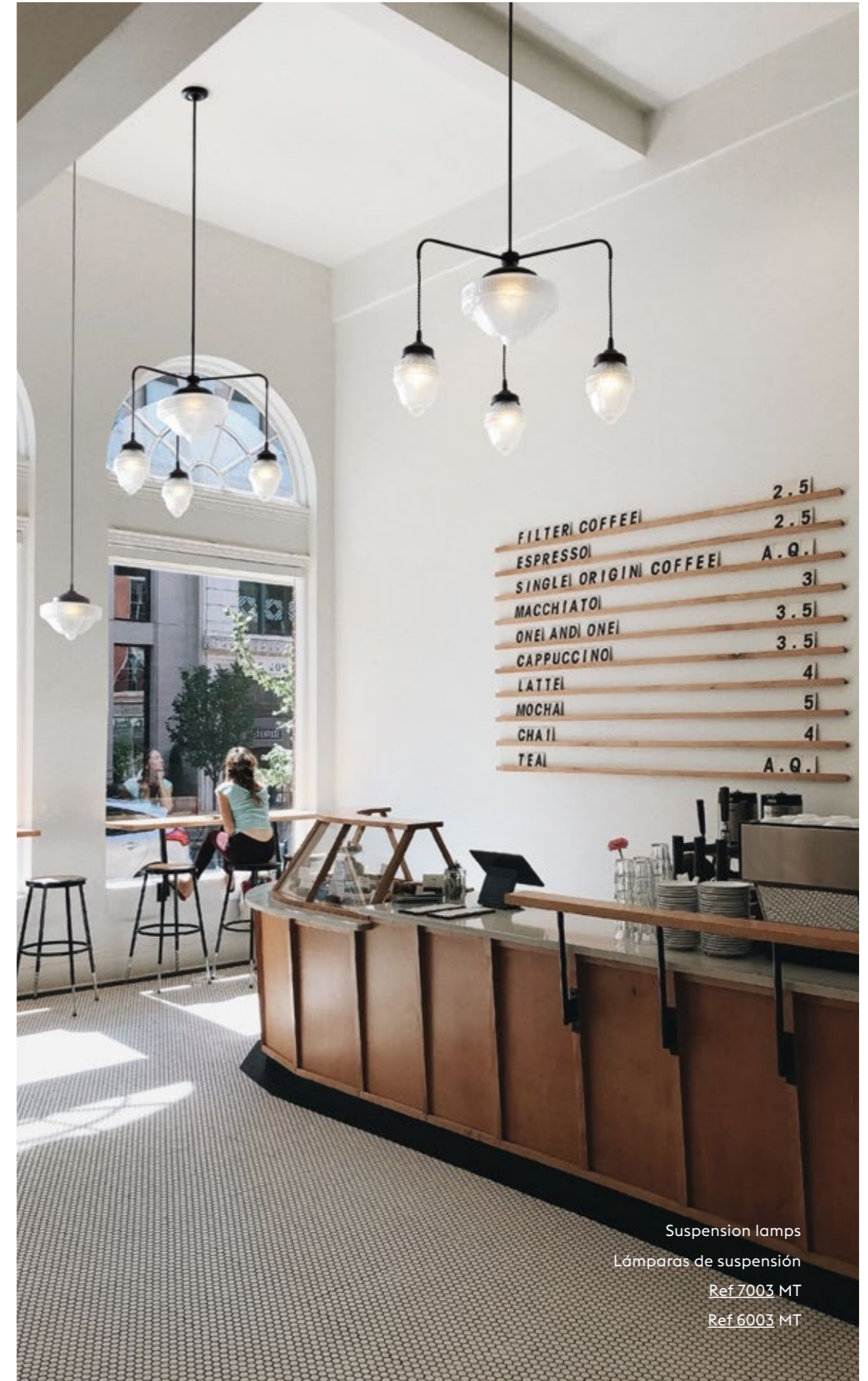

Suspension lamps
Lámparas de suspensión
Ref 7003 MT
Ref 6003 MT

Suspension lamps / Lámparas de suspensión

Ref 6000

LED 1x7W **A+**

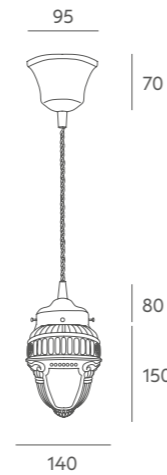

Ref 6001

LED 1x7W **A+**

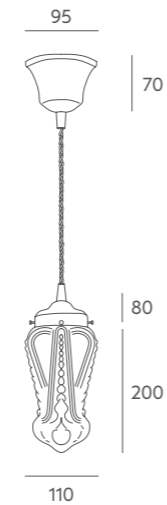

Ref 6002

LED 1x7W **A+**

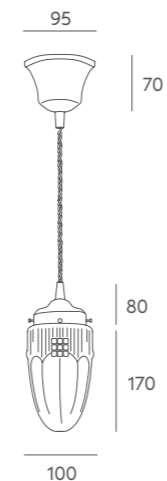

Ref 6003

LED 1x7W **A+**

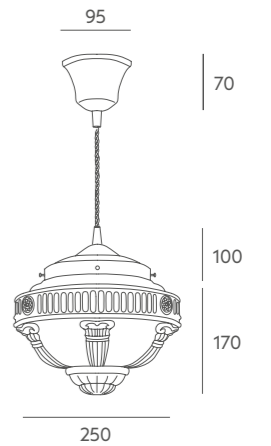

Ref 7003

LED 4x7W **A+**

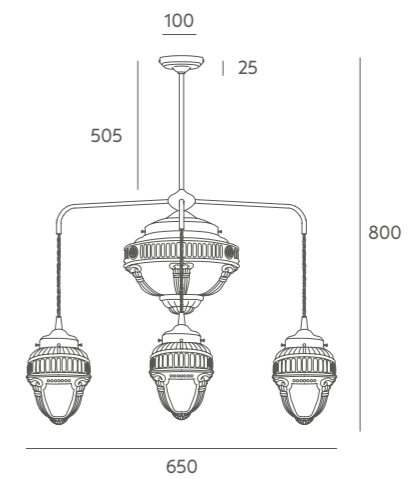

Tecnical data

Frame: painted iron metal.

Details: acid or transparent glass shades. Black plaited cable.

Recommended Bulb: E-27 7W (not included).

Important: the standard cable length is 1 metre, if you need special size please contact our Customer Support Department. Ref: 7003 standard metal bar is 50 cm, for special sizes contact us. We can evaluate to change coating or painting colour for project with a minimum quantity of pieces, please check with us.

Finishes Acabados

Metal Colour / Acabado Metal



NMT

Glass / Cristal



MT TR

Información técnica

Cuerpo: metal hierro pintado.

Detalles: tulipas de cristal al ácido (MT) o transparentes. Cable trenzado negro.

Bombilla recomendada: E-27 7W (no incluida).

Importante: la longitud del cable estándar es de 1 metro, si desea una medida especial no dude en ponerse en contacto con nosotros. Ref: 7003 tiza medida estándar de 50 cm. Para medidas especiales no duden en consultarnos. Se puede valorar cambios de color baño o pintura para proyectos con un mínimo de unidades, no duden en consultarnos.



Suspension lamps / Lámparas de suspensión

Ref 6010-30

LED 1x7W **A+**



Ref 6010-20

LED 1x7W **A+**

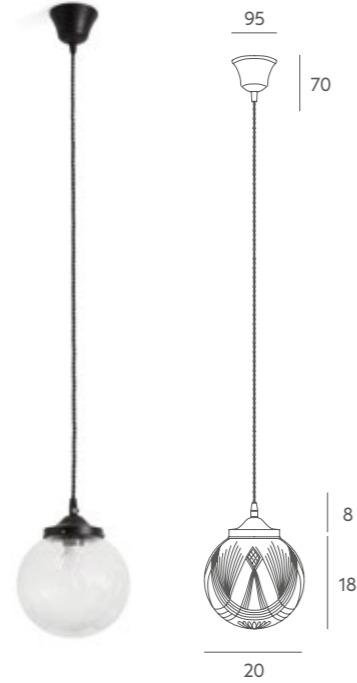

Ref 6010-16

LED 1x7W **A+**

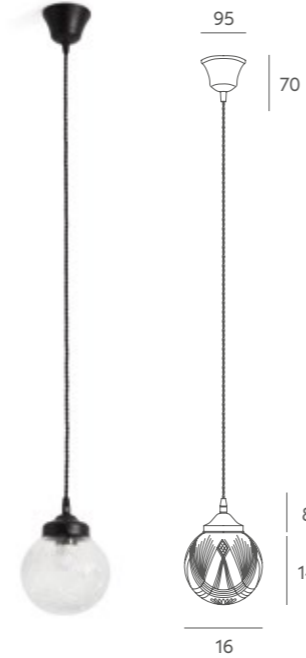

Tecnical data

Frame: painted iron metal.

Details: color or transparent glass shades. Black plaited cable.

Recommended Bulb: E-27 7W (not included).

Important: the standard cable length is 1 metre, if you need special size please contact our Customer Support Department. We can value colour changes for projects with a minimum quantity.

Finishes Acabados

Metal Colour / Acabado Metal



NMT

Glass / Cristal



AM



AZ



TR

Información técnica

Cuerpo: metal hierro pintado.

Detalles: tulipas de cristal de color. Cable trenzado negro.

Bombilla recomendada: E-27 7W (no incluida).

Importante: la longitud del cable estándar es de 1 metro, si desea una medida especial no dude en ponerse en contacto con nosotros. Se puede valorar cambios de color para proyectos con un mínimo de unidades.



Details glasses
Detalles tulipas

LARA

1979 by Massmi

Lara evokes a comforting nostalgia, stirring memories of visit on holidays spent in a cosy French hotel, or sipping coffee in a corner café. "Lara" comes either as a flush mount ceiling lamp or as a pendant lamp with triplex opal glass.

Con Lara retornamos a un pasado tal vez por muchos reconocido, en el recuerdo del pasillo de un hotel en Lyon o sobre la barra de un vetusto café. Lara se compone de plafones de techo y colgantes en vidrio opal triplex y ácido.



Suspension lamps
Lámparas de suspensión
[Ref 6004](#) NMT
[Ref 6005](#) NMT
[Ref 6006](#) NMT



Ceiling lamps
Plafones
[Ref 3428](#) VE
[Ref 3451](#) NMT
[Ref 3433](#) NMT
[Ref 3452](#) TE

Suspension lamps
Lámparas de suspensión
[Ref 6007-18](#) VE
[Ref 6007-16](#) NMT

Suspension lamps / Lámparas de suspensión

Ref 6004

LED 1x7W A+ 



Ref 6005

LED 1x7W A+ 



Ref 6006

LED 1x7W A+ 



Ref 3452

LED 1x7W A+ 



Ref 3451

LED 1x7W A+ 



Ref 6007 - 16

LED 1x7W A+ 

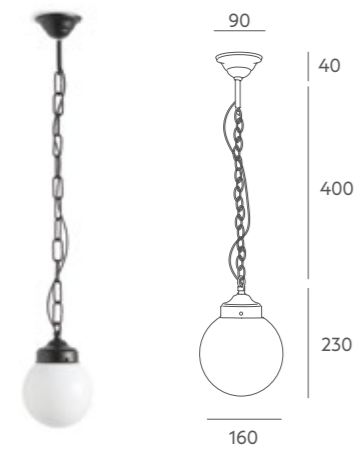

Ref 6007 - 18

LED 1x7W A+ 



Ref 3428

LED 1x7W A+ 



Ref 3450

LED 1x7W A+ 

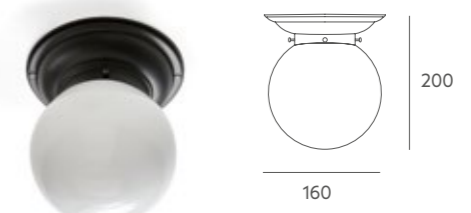

Ceiling lamps / Plafones

Ref 3433

LED 1x7W A+ 



Tecnical data

Frame: painted iron metal.

Details: spin-dried glass. Acid decoration. Ref 3450 / 6007 opal triplex. Black PVC cable.

Recommended Bulb: E-27 7W (not included).

Important: standard chain with electric cable is 40 cm, if you need special size please contact our Customer Support Department. We can value colour changes for projects with a minimum quantity.

Finishes Acabados

Metal Colour / Acabado Metal



Glass / Cristal



Información técnica

Cuerpo: metal hierro pintado.

Detalles: cristal centrifugado a molde. Decorado al ácido (MT). Ref 3450 / 6007 opal triplex. Cable PVC negro.

Bombilla recomendada: E-27 7W (no incluida).

Importante: la cadena con cable eléctrico tiene una longitud estándar de 40 cm, si desea una medida especial no dude en ponerse en contacto con nosotros. Se puede valorar cambios de color para proyectos con un mínimo de unidades.



LOUVRE

2016 by Massmi

Simple and functional, the Louvre series is reminiscent of the classic square sconces of yesteryear, updated without losing its traditional feel. It projects a focused, direct light for spotlighting a particular object with an articulated frame, for a fully adjustable shade. Louvre lamps are available in four sizes and thus harmonize with any setting.

De aspecto sobrio y funcional, Louvre remite a los clásicos apliques de cuadro, actualizado sin perder su esencia tradicional, ofrece una luz directa sobre el objeto que queremos resaltar. La pantalla difusora de luz permite un leve posicionamiento gracias a la rótula incorporada en su brazo. Disponible en cuatro tamaños lo hacen perfectamente adaptable a cualquier necesidad.



Wall lamp
Lámpara de pared
Ref 1575-40 BMT

Wall lamps / Lámparas de pared

Ref 1575-45

LED 2 x 4W **A+**

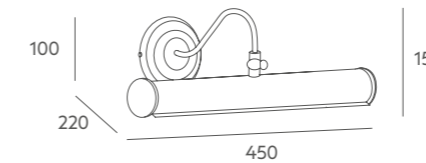

Ref 1575-40

LED 2 x 4W **A+**

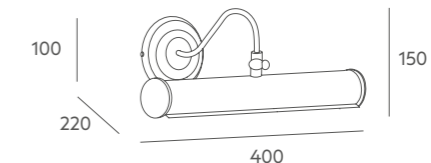

Ref 1575-30

LED 2 x 4W **A+**

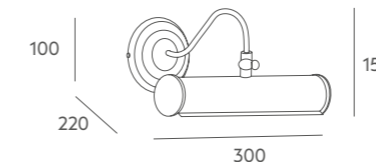

Ref 1575-25

LED 1 x 4W **A+**

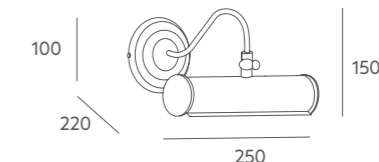

Tecnical data

Frame: painted or coated iron metal.

Details: adjustable shade. For bigger sizes than the standard, please contact our Customer Support Department.

Recommended Bulb: E-14 4W (included).

Finishes Acabados

Metal Colour / Acabado Metal

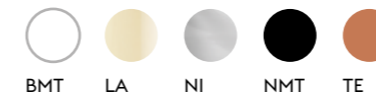

Información técnica

Cuerpo: metal hierro pintado o bañado.

Detalles: pantalla orientable. Para tamaños superiores a los estándar, consultar al departamento de atención al cliente.

Bombilla recomendada: E-14 4W (incluida).



CLUB

2001 by Massmi

Club is a complete collection that creates interesting spaces with a marked industrial retro air. Its articulated frame ensures that both the height of the lamp and the lampshade position are completely adjustable.

Club es una colección muy completa que crea interesantes espacios con un marcado aire retro industrial. Articulable de tal manera que puede adaptarse en altura y orientación de sus pantallas.

MASSMI



Wall Lamp
Lámpara de pared
Ref 1614 D



Wall lamp
Lámpara de pared
Ref 1617 NMT

SINCE 1942

Suspension lamps / Lámparas de suspensión

Ref 6986-38-45

LED 1 x 11W **A+** 

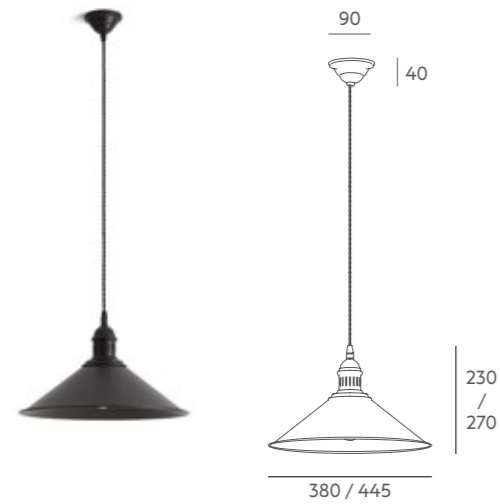

Ref 6986-30

LED 1 x 11W **A+** 



Wall lamps / Lámparas de pared

Ref 1617

LED 1 x 7W **A+** 



Ref 1616

LED 1 x 7W **A+** 

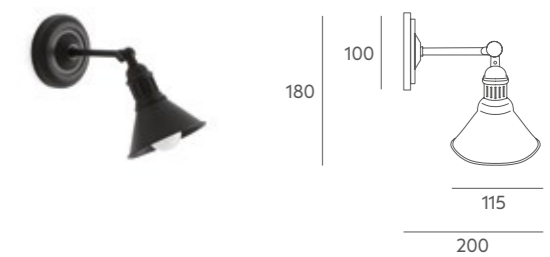

Ref 6895-1

LED 1 x 7W **A+** 

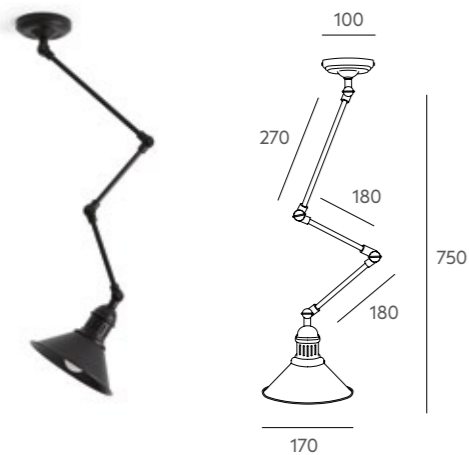

Floor lamp / Lámpara de pie

Ref 5264

LED 1 x 7W **A+** 



Ref 1614

LED 1 x 7W **A+** 

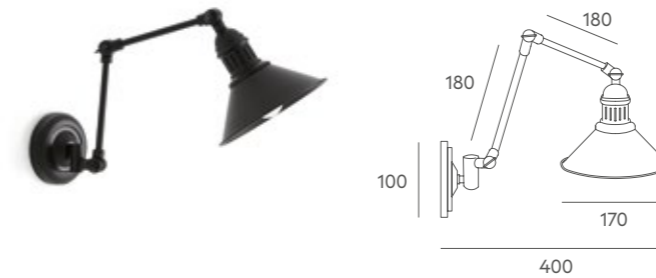
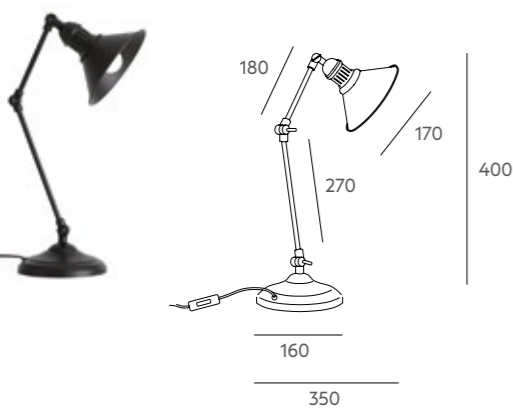

Table lamps / Lámparas de mesa

Ref 4275

LED 1 x 7W **A+** 



Ref 4276

LED 1 x 7W **A+** 

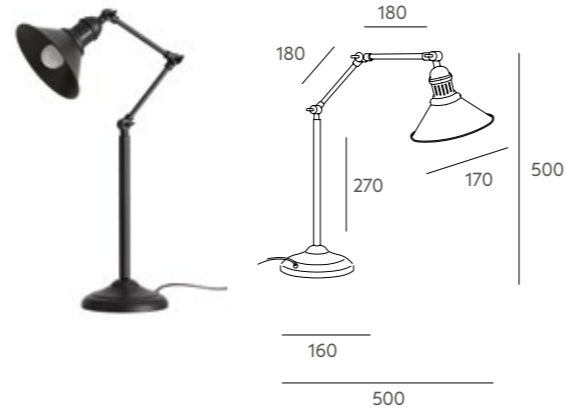

Tecnical data

Frame: painted iron metal.

Details: articulated lamps, position and sizes change. **Ref 1617** has adjustable arm. Black plaited cable for suspension lamp. Black PVC cable in floor lamp, table lamp and wall lamp.

Recommended Bulb: E-27 7W or 11W (not included).

Important: the standard cable length is 1 metre, if you need special size please contact our Customer Support Department. We can value colour changes for projects with a minimum quantity.

Finishes Acabados

Metal Colour / Acabado Metal



Información técnica

Cuerpo: metal hierro pintado.

Detalles: lámparas articuladas que varían su posición y medidas según su colocación. **Ref 1617** posee brazo regulable en altura. Cable trenzado negro en lámpara de suspensión. Cable PVC negro en lámpara de pie, lámpara de mesa y lámpara de pared.

Bombilla recomendada: E-27 7W o 11W (no incluida).

Importante: la longitud del cable estándar es de 1 metro, si desea una medida especial no dude en ponerse en contacto con nosotros. Se puede valorar cambios de color para proyectos con un mínimo de unidades.

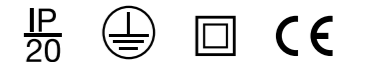

BULB

2015 by Massmi

Bulb fits in anywhere. The natural essence of Bulb emanates from the simplicity of its beechwood socket. The different combinations made possible by the two socket and bulb size options help create elegant lighting fixture compositions.

Las Bulb encajan en todo tipo de ambientes. La sencillez del portalámparas en madera de Haya es toda su esencia y naturalidad. Se presenta en dos formatos, que combinados crean sutiles y elegantes composiciones.



Suspension lamp

Lámpara de suspensión

[Ref 6992 A](#)

[Ref 6992 C](#)

[Ref 6991 B](#)

[Ref 6992 D](#)

[Ref 6991 C](#)



Suspension lamps
Lámparas de suspensión
Ref 6991 D Ref 6992 D

Suspension Lamp / Lámpara de suspensión

Ref 6992 D

1 x 40W **A+**

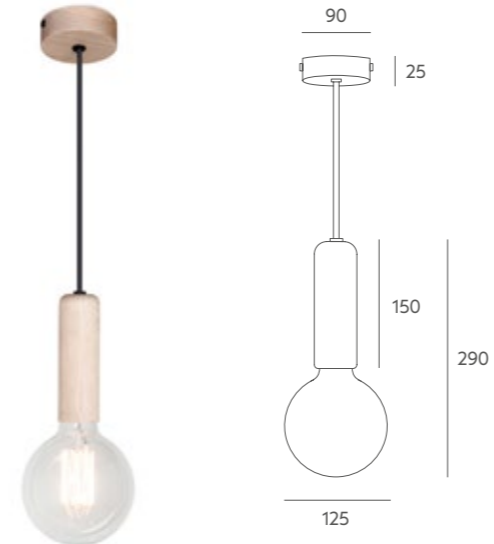

Ref 6991 D

1 x 40W **A+**

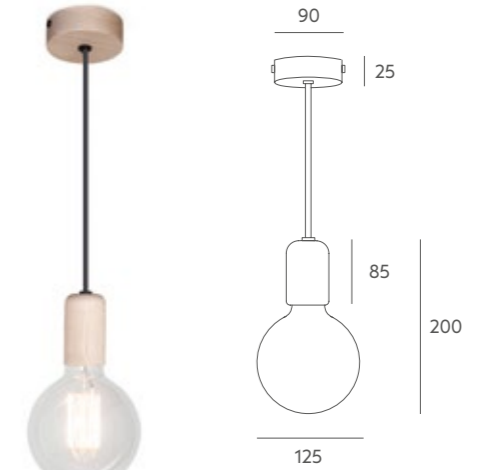
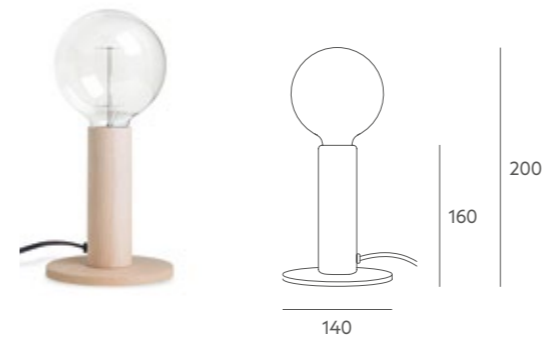

Table lamp / Lámpara de mesa

Ref 4440 D

1 x 40W **A+**



Bulbs / Bombillas

A

LED 1 x 6W **A+**



C

LED 1 x 6W **A+**



B

LED 1 x 6W **A+**



D

1 x 40W **A+**



Tecnical data

Frame: varnished beech wood.

Details: black textile cable. Ref 4440 black PVC cable.

Recommended Bulb: A, B, C E-27 6W LED o D E-27 40W Nostalgic Edison bulb (included).

Important: the standard cable length is 1 metre, if you need special size please contact our Customer Support Department.

Finishes Acabados

Wood / Madera



HA

Información técnica

Cuerpo: madera de haya barnizada.

Detalles: cable textil negro. Ref 4440 cable PVC negro.

Bombilla recomendada: A, B, C E-27 6W LED o D E-27 40W Bombilla nostálgica Edison (incluida).

Importante: la longitud del cable estándar es de 1 metro, si desea una medida especial no dude en ponerse en contacto con nosotros.



KANATAN

2021 by Massmi

A meeting between past and present by combining materials. The lampshade made with an upholstered parchment creates a contrast with the black metal body. It's a bet to obtain modern places with an artisan touch.

Un punto de encuentro entre el pasado y el presente a través de la combinación de los materiales que la conforman. Un pergamino tapizado da forma a la pantalla creando de esta manera un contraste con el cuerpo de metal de acabado negro mate. Apuesta por crear espacios modernos con un pequeño toque artesanal.



MASSMI

Table lamp
Lámpara de mesa
Ref 4464



SINCE 1942

Suspension lamp
Lámpara de suspension
Ref 6863

Table lamps
Lámparas de mesa
Ref 4463 Ref 4464

Wall lamp
Lámpara de pared
Ref 1463

Floor lamp
Lámpara de pie
Ref 5463

Suspension lamp / Lámpara de suspensión

Ref 6863

LED 1 x 6W **A+** 



Floor lamp / Lámpara de pie

Ref 5463

LED 1 x 6W **A+** 



Wall lamp / Lámpara de pared

Ref 1463

LED 1 x 6W **A+** 

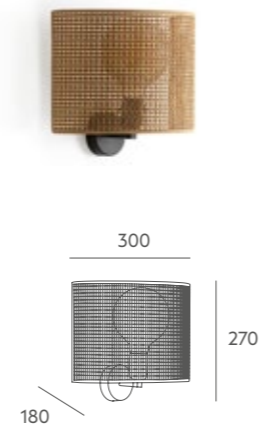

Table lamps / Lámparas de mesa

Ref 4464

LED 1 x 6W **A+** 



Ref 4463

LED 1 x 6W **A+** 



Tecnichal data

Frame: painted iron metal.

Details: grating shade. Black PVC cable.

Recommended Bulb: E-27 6W LED decorative bulb (not included).

Important: the standard cable length is 1 metre, if you need special size please contact our Customer Support Department.

Finishes Acabados

Metal Colour / Acabado Metal



NMT

Shade / Pantalla



RE

Información técnica

Cuerpo: metal hierro pintado.

Detalles: pantalla rejilla. Cable PVC negro.

Bombilla recomendada: E-27 6W LED bombilla decorativa (no incluida).

Importante: la longitud del cable estándar es de 1 metro, si desea una medida especial no dude en ponerse en contacto con nosotros.

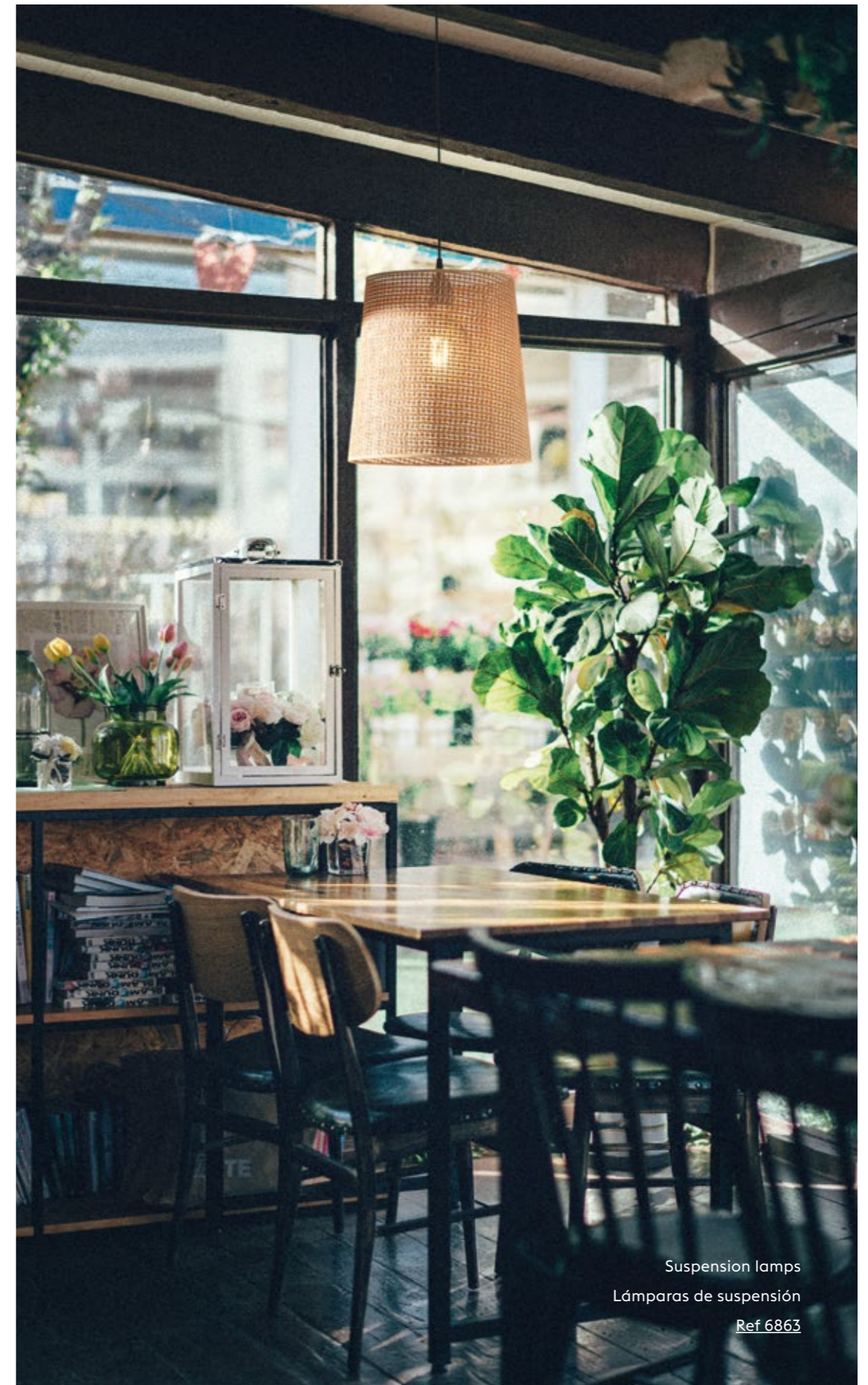

Suspension lamps
Lámparas de suspensión
Ref 6863

GIRA

1990 by Massmi

Inspired by an original design from 1950, the functional essence and basic geometry of Gira revolves around the double articulation in the middle of the pivoting arm, positioned at a right angle from the vertical axis. Massmi began to manufacture this collection in the 1990s. Today, we continue to be proud of Gira for the way it has risen above fashion trends to find its place among the classics.

Inspirada en un diseño de 1950, la esencia funcional y lo que define la geometría básica de Gira está en el doble giro de su brazo articulado por la mitad y en ángulo recto con el fuste. Esta colección se comenzó a fabricar en los años 90 en Massmi, nos sentimos orgullosos de ella porque ha conseguido superar las tendencias y encontrar siempre su lugar.

MASSMI



Table lamp
Lámpara de mesa
[Ref 4158 VE BL](#)



Wall lamp
Lámpara de pared
[Ref 1152 D NE](#)

Floor lamp
Lámpara de pie
[Ref 5134 D BL](#)

Table lamp
Lámpara de mesa
[Ref 4158 NMT NE](#)

Wall lamp
Lámpara de pared
[Ref 1151 NMT NE](#)

SINCE 1942



Wall lamp
Lámpara de pared
Ref 1152 GR NE

Wall lamps / Lámparas de pared

Ref 1151

LED 1 x 7W **A+**

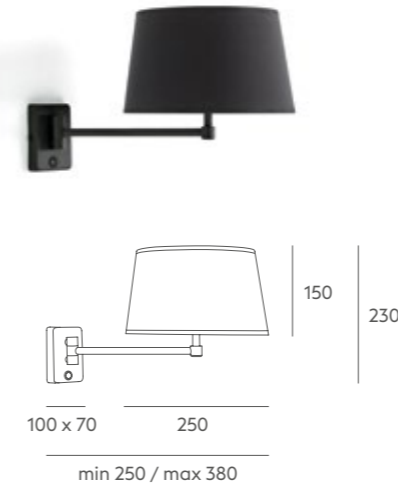

Ref 1152

LED 1 x 7W **A+**



Floor lamp / Lámpara de pie

Ref 5134

LED 1 x 11W **A+**



Table lamp / Lámpara de mesa

Ref 4158

LED 1 x 7W **A+**

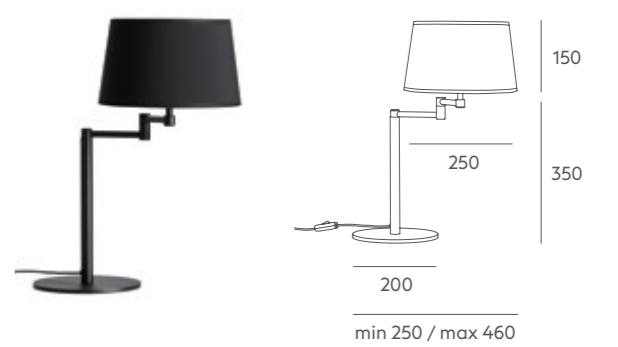

Tecnical data

Frame: painted iron metal.

Details: translucent cotton shade. Black PVC cable. Wall lamps with push-button switch.

Recommended Bulb: E-27 7W or 11W LED (not included).

Important: we can evaluate to change coating or painting colour for project with a minimum quantity of pieces, please check with us.

Finishes / Acabados

Metal Colour / Acabado Metal



Shade / Pantalla



Información técnica

Cuerpo: metal hierro pintado.

Detalles: pantalla tela de algodón traslúcido. Cable PVC negro. Apliques con interruptor de pulsador.

Bombilla recomendada: E-27 7W o 11W LED (no incluida).

Importante: se puede valorar cambios de color baño o pintura para proyectos con un mínimo de unidades, no duden en consultarnos.

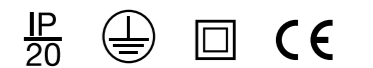

SIXTIE

2008 by Massmi

Sixtie appeared in the original Massmi catalog back in the 1960s. Its original metal shade has been replaced with an updated cloth shade, adding elegance, warmth and contemporary.

Sixtie tiene su origen ya en nuestro catálogo en la década de los 60, cuando en lugar de una pantalla de tela se realizaba en metal, ahora actualizada desde un punto de vista más elegante, cálido y contemporáneo.

MASSMI



SINCE 1942

Table lamps
Lámparas de mesa
[Ref 4459 VE BL](#)

[Ref 4460 BMT BL](#)

Floor lamp
Lámpara de pie
[Ref 5459 NMT NE](#)

Table lamps
Lámparas de mesa
[Ref 4460 GR NE](#)

[Ref 4459 GR NE](#)

Table lamps / Lámparas de mesa

Ref 4460

LED 1 x 11W **A+**

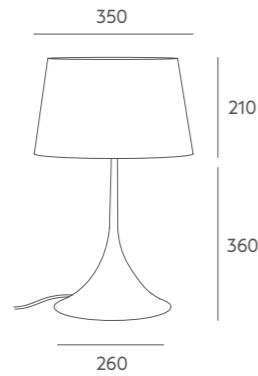

Ref 4459

LED 1 x 7W **A+**

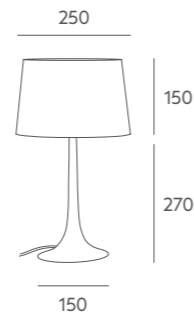

Floor lamp / Lámpara de pie

Ref 5459

LED 1 x 11W **A+**

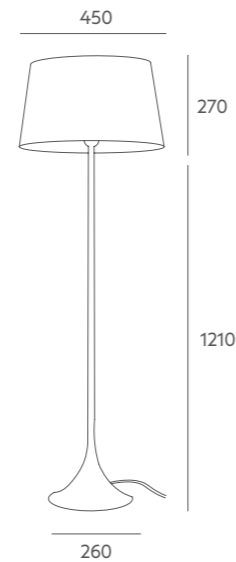

Tecnical data

Frame: painted or coated iron metal.

Details: traslucent cotton shade. Black PVC cable.

Recommended Bulb: E-27 7W or 11W LED (not included).

Important: we can evaluate to change coating or painting colour for project with a minimun quantity of pieces, please check with us.

Finishes Acabados

Metal Colour / Acabado Metal



Shade / Pantalla



Información técnica

Cuerpo: metal hierro pintado o bañado.

Detalles: pantalla tela de algodón traslúcido. Cable PVC negro.

Bombilla recomendada: E-27 7W o 11W LED (no incluida).

Importante: se puede valorar cambios de color baño o pintura para proyectos con un mínimo de unidades, no duden en consultarnos.



Table lamp
Lámpara de mesa
Ref 4460 D NE

VALLISE

2016 by Massmi

Our Vallise lamps, with their airy look, are designed and manufactured to be simple, easy, and familiar. Both the table lamp and floor lamp are perfect for reading, but because of the cone-shaped shade, provide mood lighting as well as direct light. The lampshade is fully adjustable.

Las Vallise tienen un aspecto de gran ligereza, pensadas y producidas como pieza simple, fácil y cercana. Tanto en su versión pie como sobremesa son lámparas de lectura que nos ofrecen una luz directa y a la vez ambiental a través de su pantalla cónica. La rótula que soporta su pantalla es orientable.



Floor lamp
Lámpara de pie
Ref 5436 BMT

Floor lamp / Lámpara de pie

Ref 5436

LED 1 x 11W **A+**



Table lamp / Lámpara de mesa

Ref 4436

LED 1 x 11W **A+**

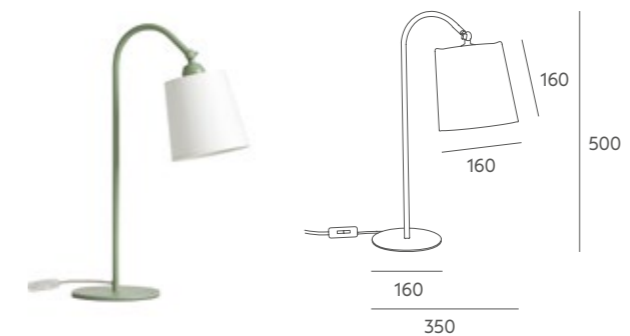

Tecnical data

Frame: painted iron metal.

Details: white linen shade. Transparent PVC cable.

Recommended Bulb: E-27 11W LED (not included).

Important: we can evaluate to change coating or painting colour for project with a minimum quantity of pieces, please check with us.

Finishes Acabados

Metal Colour / Acabado Metal



Shade / Pantalla



Información técnica

Cuerpo: metal hierro pintado.

Detalles: pantalla de tela lino blanco. Cable PVC transparente.

Bombilla recomendada: E-27 11W LED (no incluida).

Importante: se puede valorar cambios de color baño o pintura para proyectos con un mínimo de unidades, no duden en consultarnos.



HOLD

2008 by Massmi

Depending on how you look at it, Hold is a table-lamp or a lamp-table, a deft update of the classic wooden side table complete with its own light. Perfect to use next to a bed or armchair, Hold fulfills its role with simple elegance.

Hold es una mesita auxiliar con lámpara incorporada o viceversa, una sencilla y actual revisión del clásico velador de madera con luz. Reduciendo la forma de este eterno mueble auxiliar a la esencia máxima, funciona tanto como mesilla de noche, al lado de la cama, o como mesilla de salón, al lado del sofá. Hold es honesto y cumple con su función.

MASSMI



Oak finish
Acabado roble



Floor lamps
Lámparas de pie
Ref 5382 BMT BL BL
Ref 5382 NMT RO NE

SINCE 1942

Floor lamp / Lámpara de pie

Ref 5382

LED 1 x 11W **A+**

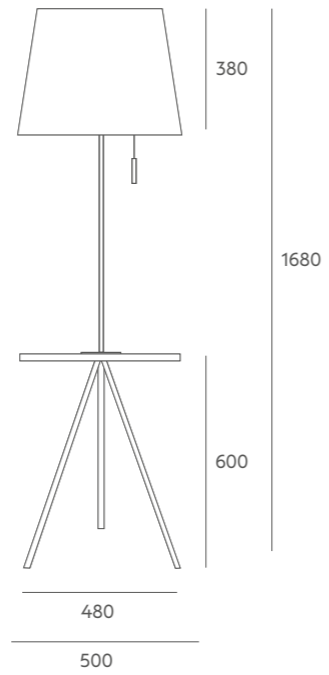

Tecnical data

Frame: painted iron metal. Lacquered wood table or oak.

Details: cotton shade. Black or transparent PVC cable. Chain switch with painted handle.

Recommended Bulb: E-27 11W LED (not included).

Finishes Acabados

Metal Colour / Acabado Metal



BMT NMT

Cable / Cable



TR NE

Wood / Madera



BL RO

Shade / Pantalla



BL NE

Información técnica

Cuerpo: metal hierro pintado. Mesa de madera lacada blanca o acabado roble.

Detalles: pantalla tela de algodón. Cable PVC negro o transparente. Interruptor de tirador con detalle lacado.

Bombilla recomendada: E-27 11W LED (no incluida).



Floor lamp
Lámpara de pie
Ref 5382 NMT RO NE

ATHINA

2016 by Massmi

Athina combines a satin steel or painted base with a cylindrical cloth shade that seems to float in the air while the play of light and shadow firmly grounds the structure. Athina is a contemporary collection of lighting.

Athina combina el acero satinado o pintado con la tela de una pantalla cilíndrica de sujeción interna que parece flotar en el aire, mientras su sombra proyectada en la base la afianza en el suelo. Athina es una colección de lámparas con un marcado acento contemporáneo.

Floor lamp
Lámpara de pie
Ref 5456 BMT BL

Table lamps
Lámparas de mesa
Ref 4456 NMT NE

Table lamps
Lámparas de mesa
Ref 4456 BMT BL



Floor lamp
Lámpara de pie
Ref 5456 NMT NE



Floor lamp / Lámpara de pie

Ref 5456

LED 1 x 11W **A+**

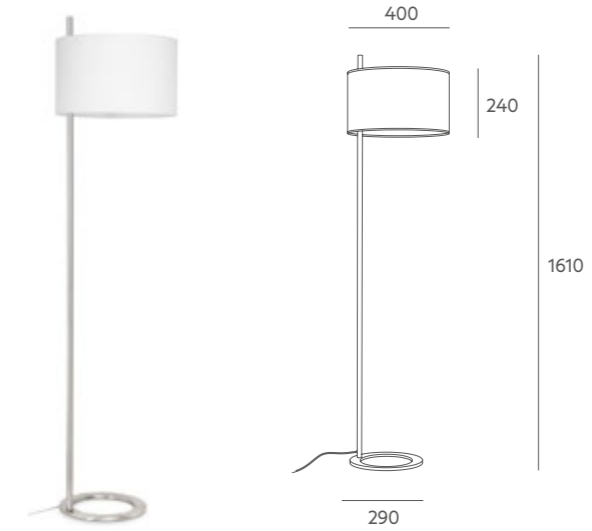

Table lamp / Lámpara de mesa

Ref 4456

LED 1 x 7W **A+**



Tecnical data

Frame: painted or coated iron metal.

Details: translucent cotton shade. Empty bases by laser cut. Black or transparent PVC cable.

Recommended Bulb: E-27 7W or 11W LED (not included).

Important: we can evaluate to change coating or painting colour for project with a minimum quantity of pieces, please check with us.

Finishes Acabados

Metal Colour / Acabado Metal

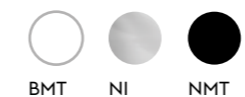

Cable / Cable

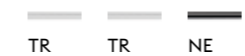

Shade / Pantalla



Información técnica

Cuerpo: metal hierro pintado o bañado.

Details: pantalla tela de algodón traslucido. Bases vacías en su interior cortadas a láser. Cable PVC negro o transparente.

Bombilla recomendada: E-27 7W o 11W LED (no incluida).

Importante: se puede valorar cambios de color baño o pintura para proyectos con un mínimo de unidades, no duden en consultarnos.



ATRIUM

2006 by Massmi

Its dramatic dimensions and single-tranche articulated arm give Atrium a bold geometric look. The inclined shaft houses a pivoting axis to direct the light with more precision. The lamp comes with a traditional opaque shade in white cotton.

Esta pieza de contundente dimensión se construye en torno a su brazo articulado, de tramo único y en ángulo inclinado, que dibuja su elegante geometría. La rótula en el eje vertical del fuste proporciona una mejor orientación. Todo el beneficio de una articulación precisa, con pantalla tradicional en cotton opaco blanco.



MASSMI

SINCE 1942

Floor lamp
Lámpara de pie
Ref 5389

Floor lamp / Lámpara de pie
Ref 5389
LED 1 x 11W **A+**

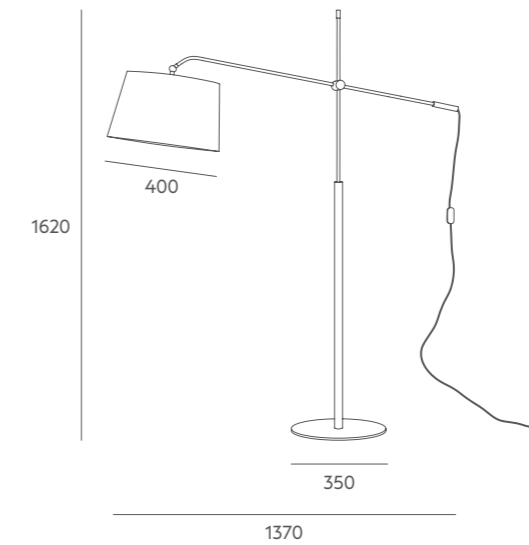

Tecnical data

Frame: chromed iron metal.
Details: white opaque cotton shade. Adjustable lighting fixture. Transparent PVC cable.
Recommended Bulb: E-27 11W LED (not included).

Finishes Acabados

Metal Colour / Acabado Metal



CR

Shade / Pantalla



BL

Información técnica

Cuerpo: metal hierro bañado cromo.
Detalles: pantalla tela de algodón opaco blanco. Regulable en altura, extensible y orientable. Cable transparente PVC.
Bombilla recomendada: E-27 11W LED (no incluida).



FUSTA

2011 by Nacho Timón

Fusta is a modern and elegant collection of lighting fixtures that incorporates a lamp into an actual side table. Fusta is the perfect lamp to put either next to a sofa or armchair or to adorn a special reading nook. It embodies practicality at its best.

Fusta aporta una versión racional, moderna y elegante a este tipo de luminarias que integran mueble auxiliar y lámpara. Situada en un rincón de lectura, junto a una butaca o a orillas del sofá es sorprendentemente funcional.

MASSMI



Oak finish
Acabado roble

Floor lamps
Lámparas de pie
Ref 5390 RO Ref 5391 BL



SINCE 1942

Floor lamp / Lámpara de pie

Ref 5390

LED 1 x 11W **A+**

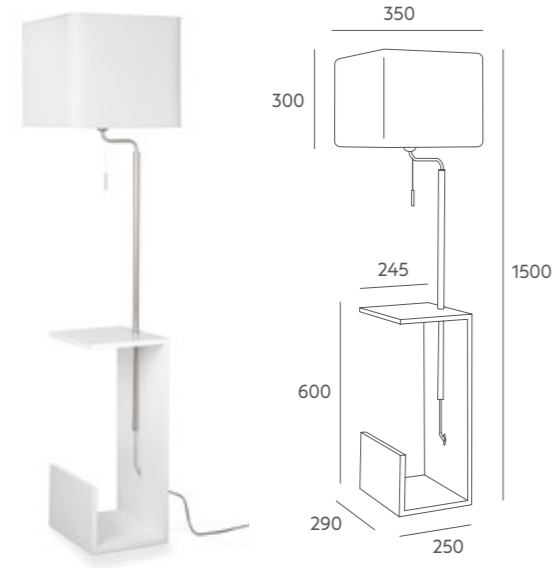

Ref 5391

LED 1 x 11W **A+**

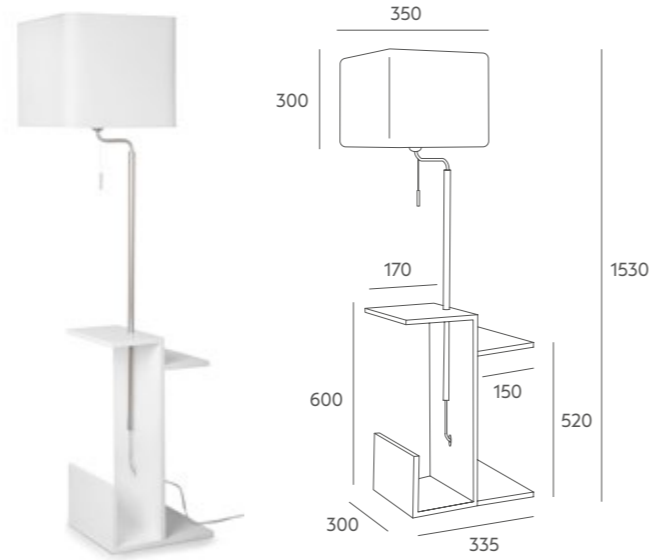

Tecnical data

Frame: satin nickel iron metal. Lacquered wood table or oak.

Details: white cotton shade with top diffuser (partial).
Transparent PVC cable. Satin nickel chain switch.

Recommended Bulb: E-27 11W LED (not included).

Finishes Acabados

Wood / Madera



BL

RO

Shade / Pantalla



BL

Metal Colour / Acabado Metal



NI

Información técnica

Cuerpo: metal hierro acabado en niquel satinado. Mesa de madera lacada o roble.

Detalles: pantalla algodón con difusor superior parcial.
Cable transparent PVC. Interruptor de tirador con detalle en niquel satinado.

Bombilla recomendada: E-27 11W LED (no incluida).



Floor lamp
Lámpara de pie
Ref 5391 RO

MINA

2012 by Massmi

Mina has a simple, double-jointed mechanism that makes this lamp fully adjustable. The shade pivots in a 90° angle to focus the light in any direction. Its airy design gives Mina a familiar look, but with a personality all its own.

El sencillo mecanismo de Mina se consigue mediante una doble rótula en su brazo que permite cambiar la altura de la pantalla para adaptarse a las necesidades del usuario. La pantalla ofrece una rotación de 90° para dirigir el haz de luz hacia donde convenga. La ligereza de su estructura confieren a Mina un aire próximo y a la vez una marcada personalidad.



Floor lamp
Lámpara de pie
Ref 5393_NMT NE

MASSMI

SINCE 1942

Floor lamp / Lámpara de pie

Ref 5393 BMT

LED 1 x 11W **A+**



Ref 5393 NI

LED 1 x 11W **A+**



Ref 5393 NMT

LED 1 x 11W **A+**

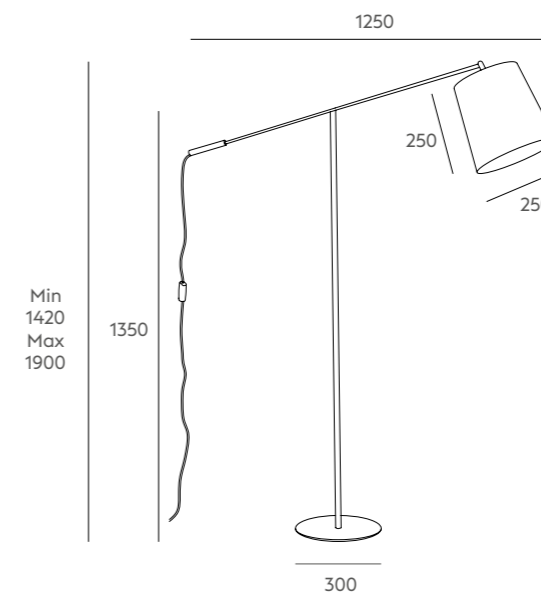

Tecnical data

Frame: painted or coated iron metal.

Details: white or black opaque cotton shade. Adjustable lighting fixture. Black or transparent PVC cable.

Recommended Bulb: E-27 11W LED (not included).

Finishes Acabados

Metal Colour / Acabado Metal

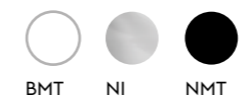

Cable / Cable

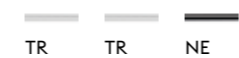

Shade / Pantalla



Información técnica

Cuerpo: metal hierro pintado o bañado.

Detalles: pantalla tela de algodón opaco blanco o negro. Lámpara basculante y orientable. Cable PVC negro o transparente.

Bombilla recomendada: E-27 11W LED (no incluida).



MANHATTAN

2021 by Massmi

Manhattan enriches the space using concret materials: the pleated parchment as artisan work and metal in the opposite. Simplicity, elegance and timelessness are the main features.

Manhattan enriquece el espacio con el uso de materiales por los que apuesta este diseño. Utiliza pergamino plisado que nos traslada en el tiempo, creando un punto de inflexión al combinarlo con el metal. Sencillez, elegancia y atemporalidad definen la colección.



Pleated parchment detail
Detalle pergamino plisado

Suspension lamp
Lámpara de suspensión
[Ref 6865](#)

Ceiling lamps
Plafones
[Ref 3505-25-50](#)

Table lamps
Lámparas de mesa
[Ref 4466](#)
[Ref 4465](#)

Wall lamp
Lámpara de pared
[Ref 1505](#)

Floor lamp
Lámpara de pie
[Ref 5465](#)





Table lamp
Lámpara de mesa
Ref 4465

Suspension lamp / Lámpara de suspensión

Ref 6865

LED 1 x 11W **A+**



Tables lamp / Lámparas de mesa

Ref 4466

LED 1 x 11W **A+**



Floor lamp / Lámpara de pie

Ref 5465

LED 1 x 11W **A+**



Ref 4465

LED 1 x 11W **A+**



Wall lamp / Lámpara de pared

Ref 1505

LED 1 x 11W **A+**

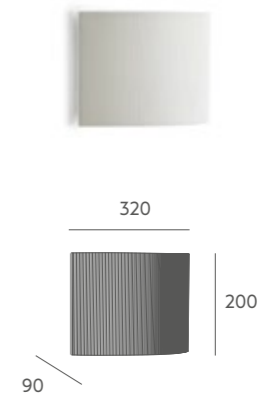

Ceiling lamp / Plafón

Ref 3505

LED Ø 25, 2 x 7W

LED Ø 50, 2 x 11W

LED Ø 70, 4 x 11W **A+**

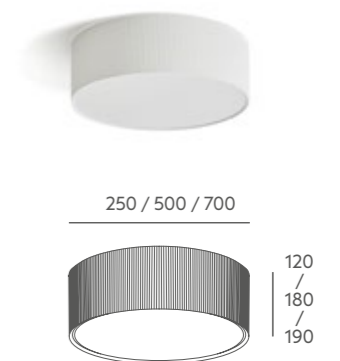

Tecnical data

Frame: painted iron metal.

Details: pleated parchment shade. Black PVC cable. Ceiling lamp with stone sockets and magnet system to hang the shade.

Recommended Bulb: E-27 7W or 11W LED (not included).

Important: standard length of wire is 1 metre, if you need special length please contact us.

Finishes Acabados

Metal Colour / Acabado Metal



NMT

Shade / Pantalla



PLI

Información técnica

Cuerpo: metal hierro pintado.

Detalles: pantalla pergamino plisado. Cable PVC negro. Versión plafón, difusor de pergamino blanco. portalámparas de piedra y sistema de sujeción de la pantalla con imanes.

Bombilla recomendada: E-27 7W o 11W LED (no incluida).

Importante: la longitud del cable estándar es de 1 metro, si se desea una medida especial póngase en contacto con nosotros.



TO BE

2007 by Massmi

To Be floats in the air on a thin steel cable. The lamp is balanced with a concealed counterweight, making the height of To Be fully adjustable.

To Be flota en el aire suspendida por un fino cable de acero y equilibrada a modo de balanza por un sistema interior que termina con contrapeso también suspendido y permite a la lámpara ser regulada en altura.



Suspension lamp
Lámpara de suspensión
Ref 6931 BL

MASSMI

SINCE 1942

Suspension lamp / Lámpara de suspensión

Ref 6931

LED 1 x 11W **A+**

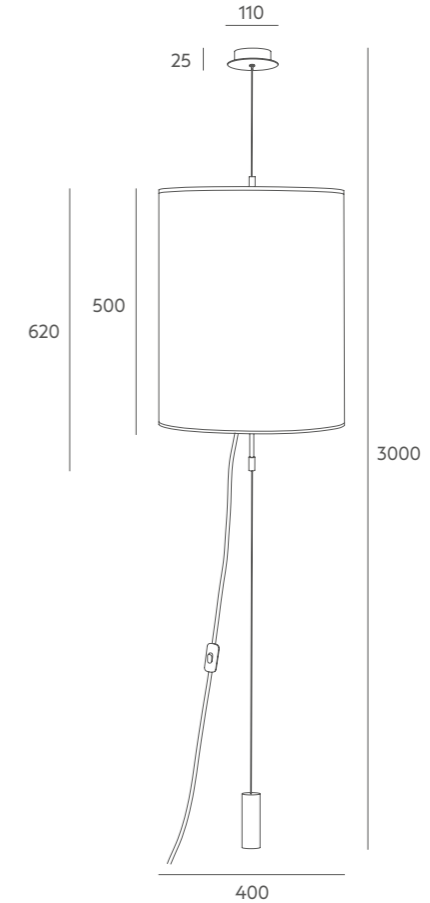

Tecnical data

Frame: painted iron metal.

Details: translucent cotton shade. Up and down lighting fixture with interior mechanism and sliding steel wire. Down connection (plug). Special support. Black or transparent PVC cable.

Recommended Bulb: E-27 11W LED (not included).

Important: the standard cable length is 3 metres, if you need special size please contact our Customer Support Department.

Finishes Acabados

Shade / Pantalla



BL

NE

Metal Colour / Acabado Metal



BMT

NMT

Cable / Cable



TR

NE

Información técnica

Cuerpo: metal hierro pintado.

Detalles: pantalla tela de algodón translúcido. Lámpara sube y baja a través de un mecanismo interior por el que desliza el cable de acero. Con instalación inferior (enchufe). Cogida de la pantalla especial. Cable PVC negro o transparente.

Bombilla recomendada: E-27 11W LED (no incluida).

Importante: la longitud del cable estándar es de 3 metros, si desea una medida especial no dude en ponerse en contacto con nosotros.



BLUR

2010 by Massmi

Inspired by the curved volumes of the Guggenheim Museum, Blur plays with the irregular halos of light that emanate from its multitiered, cone-shaped shade.

Inspirada en los juegos de volúmenes curvilíneos del museo Guggenheim, Blur juega divertida con el desenfoque que producen los halos de luz superpuestos y desiguales de su estructura cónica escalonada.



Shade detail
Detalle pantalla



Suspension Lamp
Lámpara de suspensión
Ref 6930 BL



Suspension lamp
Lámpara de suspensión
Ref 6930 NE

Suspension lamp / Lámpara de suspensión

Ref 6930

LED 1 x 11W **A+**

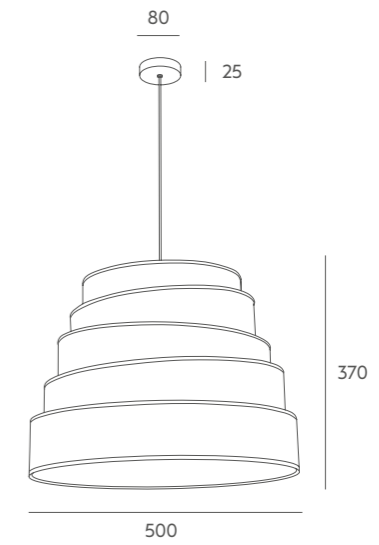

Tecnical data

Details: opaque cotton shade with diffuser of white parchment. Black or white textil cable.

Recommended Bulb: E-27 11W LED (not included).

Important: the standard cable length is 1 metre, if you need special size please contact our Customer Support Department.

Finishes Acabados

Metal Colour / Acabado Metal



BMT NMT

Shade / Pantalla



BL NE

Cable / Cable



TEX BL TEX NE

Información técnica

Detalles: pantalla tela algodón opaco con difusor de pergamino blanco. Cable textil color blanco o negro.

Bombilla recomendada: E-27 11W LED (no incluida).

Importante: la longitud del cable estándar es de 1 metro, si desea una medida especial no dude en ponerse en contacto con nosotros.



DONA

2021 by Massmi

Donna is a pendant lamp with dramatic geometric form and large-scale dimension. A simple, elegant air to any setting.

Dona se caracteriza por la contundente presencia de su pantalla de grandes dimensiones y formato rectangular. Elegante y básica que combina en cualquier ambiente.



Suspension lamp
Lámpara de suspensión
Ref 6829 AZ BMT

MASSMI

SINCE 1942

Suspension lamp / Lámpara de suspensión

Ref 6829 Cotton / Algodón AZ / BL / NE

LED 3 x 11W **A+**



Ref 6830 Linen / Lino BL / MA

LED 3 x 11W **A+**

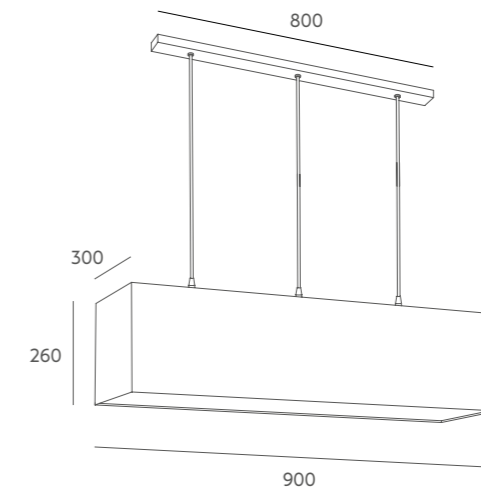

Tecnical data

Frame: painted iron metal.

Details: cotton shade or linen. White parchment diffuser. Black or transparent PVC cable.

Recommended Bulb: E-27 11W LED (not included)

Important: the standard cable length is 1 metre, if you need special size please contact our Customer Support Department.

Información técnica

Cuerpo: metal hierro pintado.

Detalles: pantalla de tela de algodón o lino. Difusor de pergamino blanco. Cable PVC negro o transparente.

Bombilla recomendada: E-27 11W LED (no incluida)

Importante: la longitud del cable estándar es de 1 metro, si desea una medida especial no dude en ponerse en contacto con nosotros.

Finishes Acabados

Shade / Pantalla



Metal Colour / Acabado Metal



Cable / Cable



BORROCO

2006 by Massmi

Borroco marks a return to the sophistication of an iconic lighting fixture. Today, this lamp continues to be a classic in our catalogue. Fully updated, Borroco is a complete series with table, and pendant lamp models. The series brings back the luxury of the gold tone of yesteryear and we add new colors.

Borroco fue en su día un retorno a la sofisticación y una actualización de la iconografía clásica en iluminación. Ha logrado sostenerse como un clásico en el corazón de nuestro catálogo. La presentamos actualizada en sus diferentes versiones de sobremesa y de techo, apostando por el lujo accesible que recupera en la decoración los dorados de siempre y se añaden nuevos colores.

MASSMI



Ceiling Lamp
Suspensión
Ref 6854 NMT NE



Suspension lamp
Lámpara de suspensión
Ref 6854 D BL

Table lamp
Lámpara de mesa
Ref 4454 D BL

SINCE 1942

Table lamps / Lámparas de mesa

Ref 4455

LED 1 x 11W **A+**

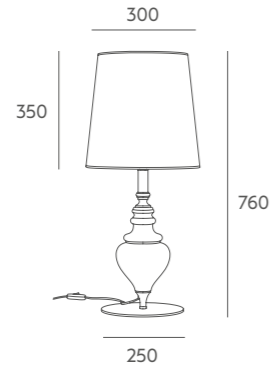

Ref 4454

LED 1 x 11W **A+**

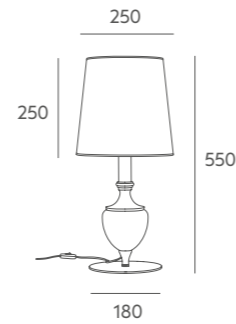

Suspension lamp / Lámpara de suspensión

Ref 6854

LED 1 x 11W **A+**

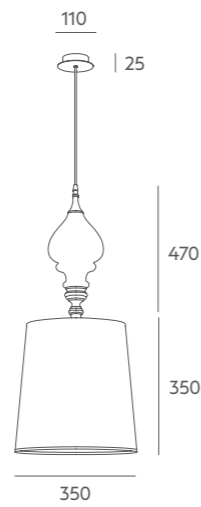

Tecnical data

Frame: painted iron metal.

Details: opaque cotton shade. Textil black or white cable for suspension lamp. Table lamp black or transparent PVC cable.

Recommended Bulb: E-27 11W LED (not included).

Important: the standard cable length is 1 metre, if you need special size please contact our Customer Support Department.

Finishes Acabados

Metal Colour / Acabado Metal



Cable / Cable



Shade / Pantalla



Información técnica

Cuerpo: metal hierro pintado.

Detalles: pantalla tela de algodón traslúcido. Cable textil negro o blanco en lámpara de suspensión. Lámpara de mesa cable PVC transparente o negro.

Bombilla recomendada: E-27 11W LED (no incluida).

Importante: la longitud del cable estándar es de 1 metro, si desea una medida especial no dude en ponerse en contacto con nosotros.



Table lamp
Lámpara de mesa
Ref 4455 BMT BL

ELEGANCE

2003 by Massmi

The Elegance collection of lamps was designed to illuminate any kind of space with a simple, clear light. The pendant model has a criss-cross structure, lending it dynamism and, of course, elegance.

Concebida para iluminar de manera sencilla y limpia tanto un entorno doméstico como otros espacios. La lámpara de suspensión Elegance de estructura cruzada se despliega desde el centro a la medida que requiera el espacio, a la ligereza de su estructura se suma un dinamismo formal muy elegante.



MASSMI

SINCE 1942

Suspension lamp
Lámpara de suspensión
Ref 7210 GR NE

Suspension lamp / Lámpara de suspensión

Ref 7210

LED 2 x 11W **A+**

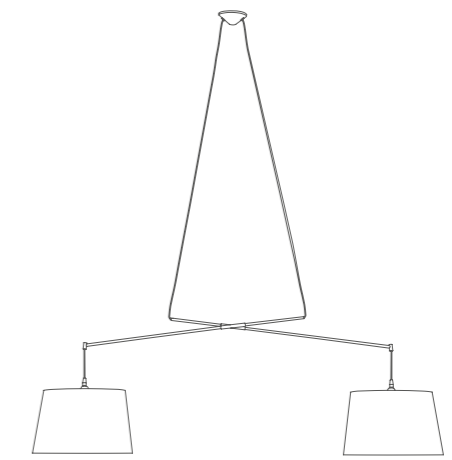
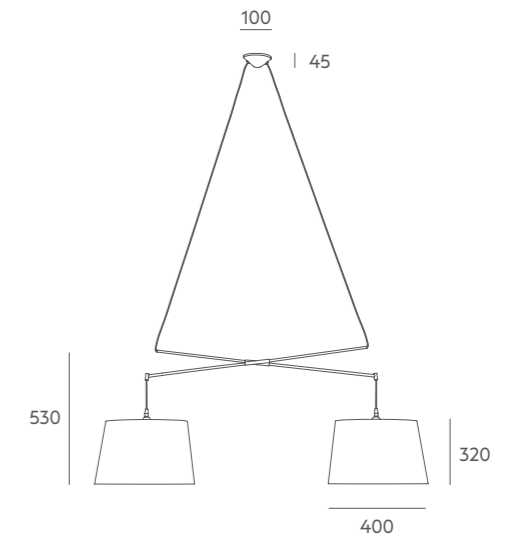

Mín 1230 / Max 2000

Tecnical data

Frame: coated iron metal.

Details: cotton shade. Black or transparent PVC cable.

Recommended Bulb: E-27 11W LED (not included).

Important: the standard cable length is 1 metre, if you need special size please contact our Customer Support Department.

Finishes Acabados

Metal Colour / Acabado Metal



NI GR

Cable / Cable



TR NE

Shade / Pantalla



BL NE

Información técnica

Cuerpo: metal hierro bañado.

Detalles: pantalla tela de algodón traslúcido. Cable PVC negro o transparente.

Bombilla recomendada: E-27 11W LED (no incluida).

Importante: la longitud del cable estándar es de 1 metro, si desea una medida especial no dude en ponerse en contacto con nosotros.





HAT

Restyling 2012

"Hat" is inspired by one of the most important design styles of the mid-twentieth century, California Modernism. The tripod-shaped tubular base inclines slightly backwards, with the articulated axis allowing for full adjustment of the shade.

Hat se inspira en uno de los estilos más relevantes del diseño de mediados del siglo XX, el modernismo californiano. La pantalla se orienta desde una rótula que puede ser direccionada allí donde sea necesaria la luz.



Suspension lamps
Lámparas de suspensión
[Ref 6953_VE / AZ](#)

Floor lamps
Lámparas de pie
[Ref 5383_VE / AZ / BMT](#)

Table lamps
Lámparas de mesa
[Ref 4425_BMT / NMT](#)



Floor lamp
Lámpara de pie
Ref 5383 VE

Suspension lamps / Lámpara de suspensión

Ref 6953

LED 1 x 11W **A+**

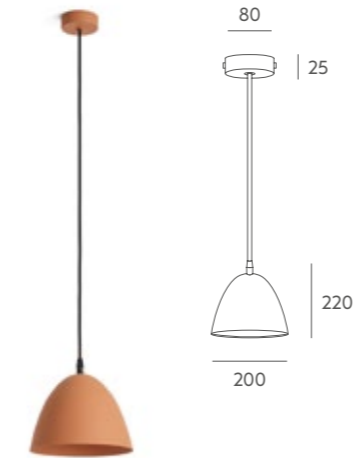

Floor lamp / Lámpara de pie

Ref 5383

LED 1 x 11W **A+**



Table lamp / Lámpara de mesa

Ref 4425

LED 1 x 11W **A+**

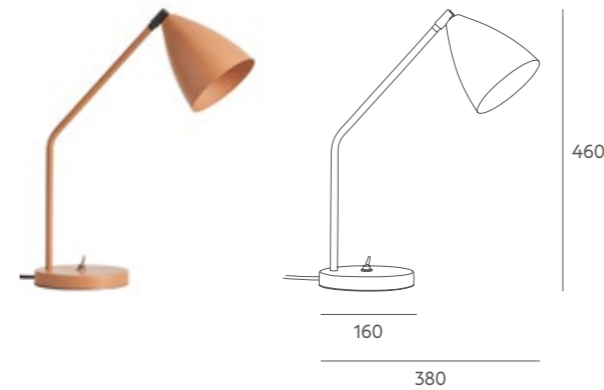

Tecnical data

Frame: painted iron metal.

Details: same coloured inside and outside. Black or transparent PVC cable. Black textile cable for suspension lamps.

Recommended Bulb: E-27 11W LED (not included).

Important: the standard cable length is 1 metre, if you need special size please contact our Customer Support Department. We can value colour changes for projects with a minimum quantity.

Finishes Acabados

Metal Colour / Acabado Metal



Información técnica

Cuerpo: metal hierro pintado.

Detalles: acabado interior mismo color que exterior. Cable PVC negro. Cable textil negro para lámparas de suspensión.

Bombilla recomendada: E-27 11W LED (no incluida).

Importante: la longitud del cable estándar es de 1 metro, si desea una medida especial no dude en ponerse en contacto con nosotros. Se puede valorar cambios de color para proyectos con un mínimo de unidades.



EXA

2017 by Massmi

Exa is an extensive collection with simple and marked lines. Perfect to create modern and elegant ambiances. Despite simplicity and minimal aesthetic it gives personallity to the space and can be used in any kind of interior projects.

Exa es una amplia colección de líneas limpias y marcadas ideal para crear ambientes modernos y elegantes. Pese a su simplicidad y estética minimalista, dota de mucha personalidad al espacio y encaja en todo tipo de proyectos de interior.

MASSMI



SINCE 1942

Floor lamp
Lámpara de pie
[Ref 5438](#) NMT

Table lamp
Lámpara de mesa
[Ref 4438](#) BMT

Wall lamp
Lámpara de pared
[Ref 1435](#) NMT

Suspension lamp
Lámpara de suspensión
[Ref 6987 - G](#) BMT

Floor lamp / Lámpara de pie

Ref 5438

LED 1 x 11W **A+** 

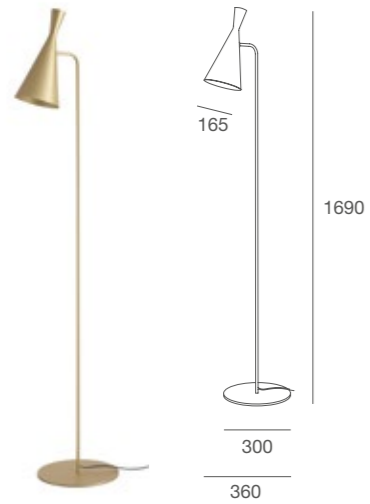

Wall lamp / Pared

Ref 1435

LED 1 x G9 4W **A+** 

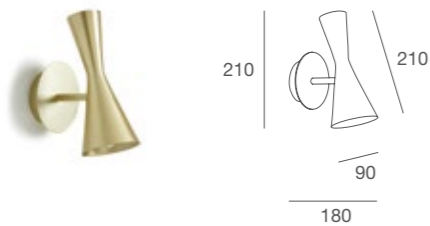

Suspension lamps / Lámparas de suspensión

Ref 6987-G

LED 1 x 11W **A+** 



Ref 6987-P

LED 1 x 7W **A+** 



Table lamp / Lámpara de mesa

Ref 4438

LED 1 x G9 4W **A+** 

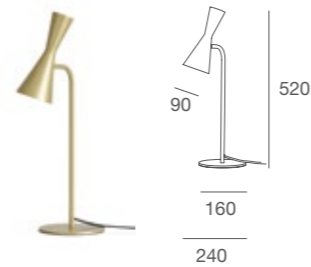

Tecnical data

Frame: painted iron metal.

Details: same coloured inside and outside. Table and floor lamps: black PVC cable for coloured metal and transparent for white metal. Textile cable for suspension lamps.

Recommended Bulb: E-27 7W or 11W LED (not included). G9 4W 3000K. 400 Lm 36° LED (included).

Important: the standard cable length is 1 metre, if you need special size please contact our Customer Support Department. We can value colour changes for projects with a minimum quantity.

Finishes Acabados

Metal Colour / Acabado Metal



Cable / Cable



Información técnica

Cuerpo: metal hierro pintado.

Detalles: acabado interior mismo color que exterior. Lámparas de mesa y pie: cable PVC negro en versiones de color y transparente para versión blanca. Cable textil para lámparas de suspensión.

Bombilla recomendada: E-27 7W o 11W LED (no incluida). G9 4W 3000K. 400 Lm 36° LED (incluida).

Importante: la longitud del cable estándar es de 1 metro, si desea una medida especial no dude en ponerse en contacto con nosotros. Se puede valorar cambios de color para proyectos con un mínimo de unidades.



Ceiling lamp

Suspensión

Ref 6987-G NMT



LITE

2014 by Massmi

Spotlights have traditionally been used in markets, cafes, and bars. "Lite" embraces this characteristic functionality and simplicity. Extremely popular in retro decor, "Lite" also works well in Nordic or rustic settings.

La lámpara de foco se la reconoce tradicionalmente en mercados, tabernas y cafeterías. Lite es un reconocimiento a esa funcionalidad y simplicidad tan característica. Hoy muy presente en estilos retroindustrial, también encaja a la perfección en espacios sacandi o rústicos.



Suspension lamps

Lámparas de suspensión

[Ref 6974 TE](#)

[Ref 6982 TE](#)

[Ref 6976 TE](#)

[Ref 6973 TE](#)



Suspension lamps
Lámparas de suspensión
Ref 6982 CO Ref 6976 NMT Ref 6974 D

Suspension lamps / Lámparas de suspensión

Ref 6973

LED 1 x 11W **A+**



Ref 6974

LED 1 x 11W **A+**

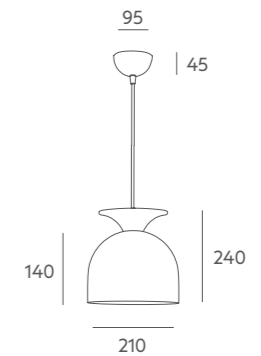

Ref 6976

LED 1 x 11W **A+**

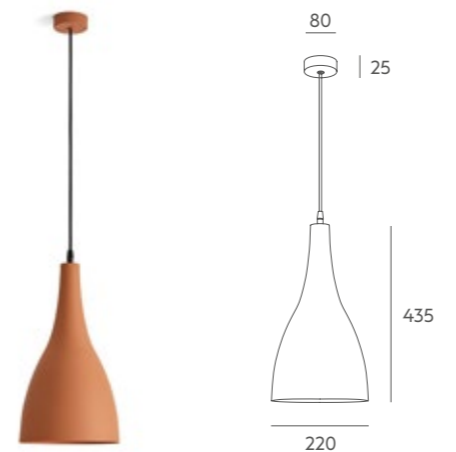

Ref 6982

1 x 40W **A+**

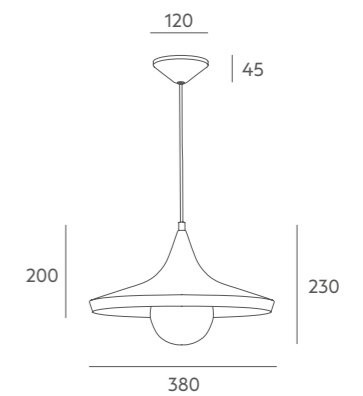

Tecnical data

Frame: painted iron metal.

Details: same coloured inside and outside. Black or white textile cable.

Recommended Bulb: E-27 11W LED (not included).
Ref 6982 E-27 40W Nostalgic Edison bulb (included).

Important: the standard cable length is 1 metre, if you need special size please contact our Customer Support Department. We can value colour changes for projects with a minimum quantity.

Finishes / Acabados

Metal Colour / Acabado Metal

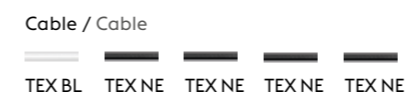

Información técnica

Cuerpo: metal hierro pintado.

Detalles: acabado interior mismo color que exterior. Cable textil negro o blanco.

Bombilla recomendada: E-27 11W LED (no incluida).
Ref 6982 E-27 40W Nostalgic Edison bulb (incluida).

Importante: la longitud del cable estándar es de 1 metro, si desea una medida especial no dude en ponerse en contacto con nosotros. Se puede valorar cambios de color para proyectos con un mínimo de unidades.



BERKA

Design 2016

The Berka collection is a versatile lamp who fits perfectly in any kind of interior projects. The cone-shaped shade has a beechwood finial to lend a contemporary air to these simple, elegant fixtures.

La colección Berka en sus diferentes versiones encaja a la perfección en todo tipo de proyectos de interior. Su marcada pantalla cónica está terminada con una pieza de madera de haya torneada que le confiere una estética muy contemporánea, sencilla y elegante.



Suspensión lamps
Lámparas de suspensión
[Ref 6983-G AZ / BMT / VE](#)

[Ref 6983 GR](#)

Table lamp
Lámpara de mesa
[Ref 4433 NMT](#)

Floor lamp
Lámpara de pie
[Ref 5433 TE](#)



Wall lamp
Lámpara de pared
Ref 1433 BMT



Suspension lamps
Lámparas de suspensión
Ref 6983-G.VE Ref 6983.TE

Floor lamp / Lámpara de pie

Ref 5433

LED 1 x 11W  

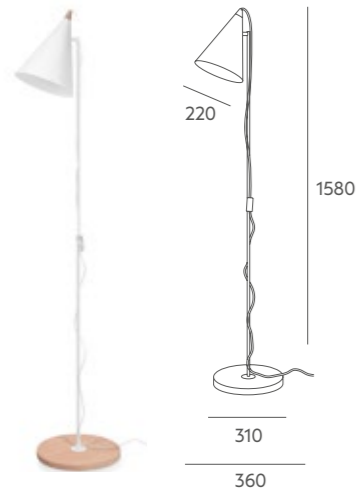

Wall lamp / Lámpara de pared

Ref 1433

LED 1 x 7W  



Suspension lamps / Lámparas de suspensión

Ref 6983 G

LED 1 x 11W  

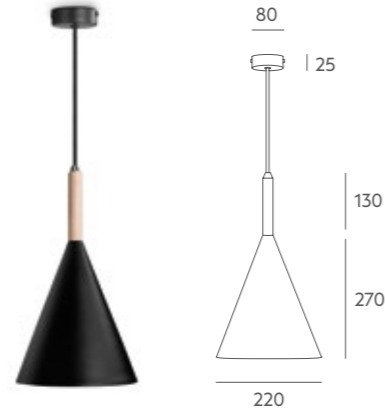

Ref 6983 P

LED 1 x 7W  



Table lamp / Lámpara de mesa

Ref 4433

LED 1 x 7W  

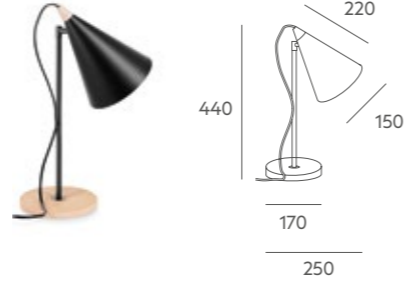

Suspension lamp
Lámpara de suspensión
Ref 6983 D

Tecnical data

Frame: painted or coated iron metal. Wooden support.

Details: same coloured inside and outside. Table and floor lamps: black and golden finishes with black PVC cable, white finish with transparent PVC cable. Textile wire for suspension lamps.

Recommended Bulb: E-27 7W or 11W LED (not included).

Important: the standard cable length is 1 metre, if you need special size please contact our Customer Support Department. We can value colour changes for projects with a minimum quantity.

Finishes Acabados

Metal Colour / Acabado Metal



Wood / Madera



Cable / Cable

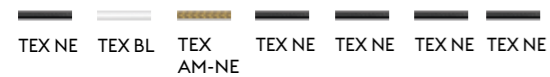

Información técnica

Cuerpo: metal hierro pintado o bañado. Soporte de madera acabado haya.

Detalles: acabado interior mismo color que exterior. Cable PVC negro en versiones dorado y negro y transparente en versión blanco para lamparas de mesa y pie. Cable textil para lámparas de suspensión.

Bombilla recomendada: E-27 7W o 11W LED (no incluida).

Importante: la longitud del cable estándar es de 1 metro, si desea una medida especial no dude en ponerse en contacto con nosotros. Se puede valorar cambios de color para proyectos con un mínimo de unidades.



GARLAND

Design 2015

Garland is a homage to the bare incandescent bulb aesthetic, which has been there from the very beginning. Stripped of unnecessary decoration and supported by a simple tubular structure, Garland becomes the star of the show in whatever decor it is used.

Garland es un homenaje a esa estética de la bombilla incandescente que tantos y tantos años nos ha acompañado. Desnuda y apoyada en una simple estructura tubular en distintos acabados pasa a ser la gran protagonista de la decoración.



MASSMI

Suspension lamps
Lámparas de suspensión
Ref 6981 AZ / TE / VE



Suspension lamp
Lámpara de suspensión
Ref 6980 VE



SINCE 1942



Suspension lamp
Lámpara de suspensión
Ref 6979 BMT

Suspension lamps / Lámparas de suspensión

Ref 6980

4 x 40W **A+**

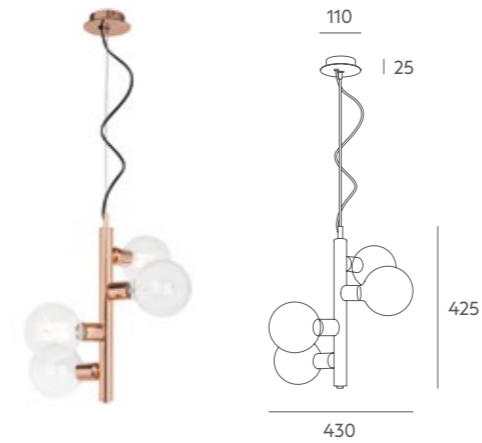

Ref 6979

3 x 40W **A+**

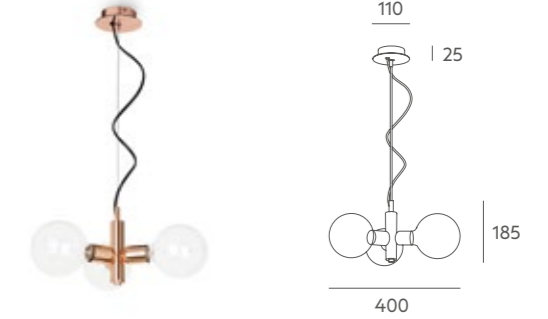

Ref 6981

1 x 40W **A+**

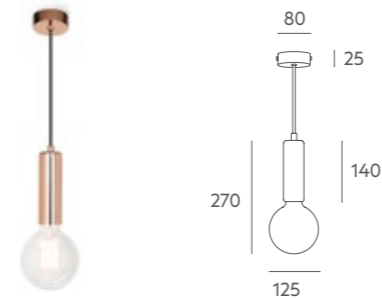
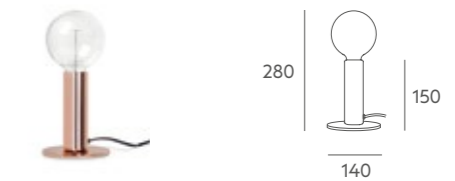

Table lamp / Lámpara de mesa

Ref 4419

1 x 40W **A+**



Tecnical data

Frame: painted or coated iron metal.

Details: black or white textil cable [Ref 6981](#). PVC cable [Ref 6979](#) [Ref 6980](#) [Ref 4419](#)

Recommended Bulb: E-27 40W Nostalgic Edison bulb (included).

Important: the standard cable length is 1 metre, if you need special size please contact our Customer Support Department. We can value colour changes for projects with a minimum quantity.

Finishes Acabados

Metal Colour / Acabado Metal



PVC wire / Cable PVC [Ref 6979](#) [Ref 6980](#)

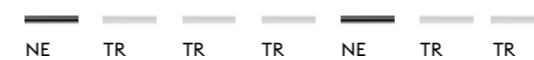

Textil wire / Cable textil [Ref 6981](#)

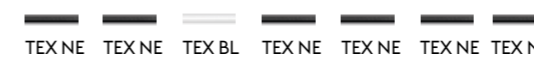

Información técnica

Cuerpo: metal hierro pintado o bañado.

Detalles: cable textil negro o blanco [Ref 6981](#). Cable PVC [Ref 6979](#) [Ref 6980](#) [Ref 4419](#)

Bombilla recomendada: E-27 40W Nostalgic Edison bulb (incluida).

Importante: la longitud del cable estándar es de 1 metro, si desea una medida especial no dude en ponerse en contacto con nosotros. Se puede valorar cambios de color para proyectos con un mínimo de unidades.



POPPOL

Design 2016

With two lampshade shapes and six colors which increase the utility of these simple dome-shaped, Poppol pendant lamps permit numerous possibilities for combinations. The beechwood accents heighten its Nordic styling.

Poppol se presta al juego compositivo de lámparas de suspensión con dos formatos de pantallas y seis colores que multiplican la utilidad de estas sencillas cúpulas luminosas. Su estilo nórdico lo acentúa el remate torneado en madera de haya.

MASSMI



SINCE 1942

Lámparas de suspensión
Suspensión lamps

[Ref 6985](#) TE / VE / BMT

[Ref 6984](#) GR / AZ / NMT

Suspension lamps / Lámparas de suspensión

Ref 6984

LED 1 x 11W **A+**

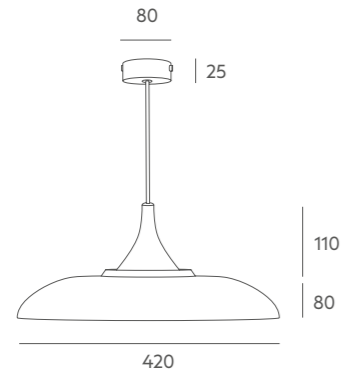

Ref 6985

LED 1 x 11W **A+**

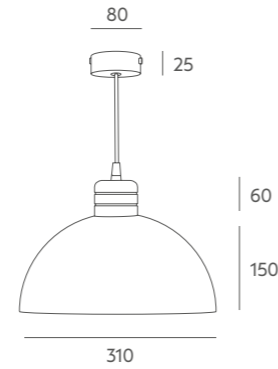

Tecnical data

Frame: painted iron metal. Beech wood holder.

Details: same coloured inside and outside. Textile cable.

Recommended Bulb: E-27 11W LED (not included).

Important: the standard cable length is 1 metre, if you need special size please contact our Customer Support Department. We can value colour changes for projects with a minimum quantity.

Finishes Acabados

Metal Colour / Acabado Metal



Cable / Cable



Wood / Madera



Información técnica

Cuerpo: metal hierro pintado. Soporte de madera acabado haya.

Detalles: acabo interior mismo color que exterior. Cable textil.

Bombilla recomendada: E-27 11W LED (no incluida).

Importante: la longitud del cable estándar es de 1 metro. Se puede valorar cambios de color para proyectos con un mínimo de unidades. Para cualquiera de estas opciones, no duden en consultarnos.



Lámpara de suspensión
Suspension lamp
Ref 6985_VE

BUBLE

Design 1970

"Buble" is 2008 version of our original 1970s design. A modern lamp with a simple tree-shaped design, "Buble" has a tubular base, available in chrome or copper finishes and fitted with opal glass spheres instead of traditional lampshades. This reedition of the Sixties piece is one of the oldest lamp in our catalogue and it fits to numerous settings.

Buble fue reeditada en el 2008, un clásico de nuestro catálogo creado en 1970. Gracias a su diseño arbolado que le confiere dinamismo a la esfera y su simplicidad, Buble es una pieza atemporal. Esta reedición de los años 70 es una de las más antiguas de nuestro catálogo y sin duda un básico en proyectos en cualquiera de sus versiones.



MASSMI

SINCE 1942

Suspension lamp
Lámpara de suspensión
Ref 6140 AZ

Ref 6139 CO
Suspension lamp
Lámpara de suspensión



Suspension lamps / Lámparas de suspensión

Ref 6138

LED 3 x 7W A+

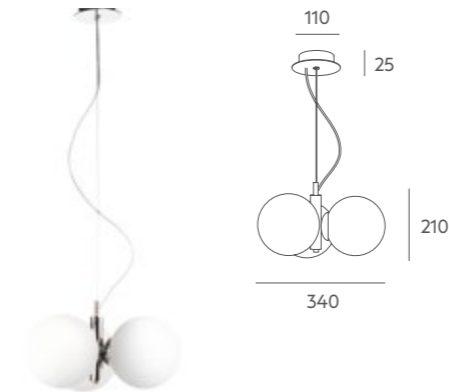

Ref 6139

LED 4 x 7W A+

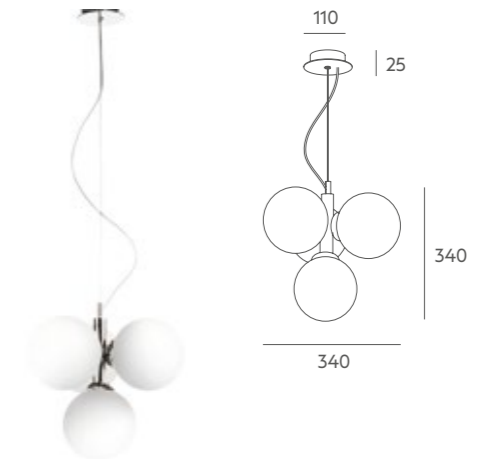

Ref 6140

LED 4 x 7W A+

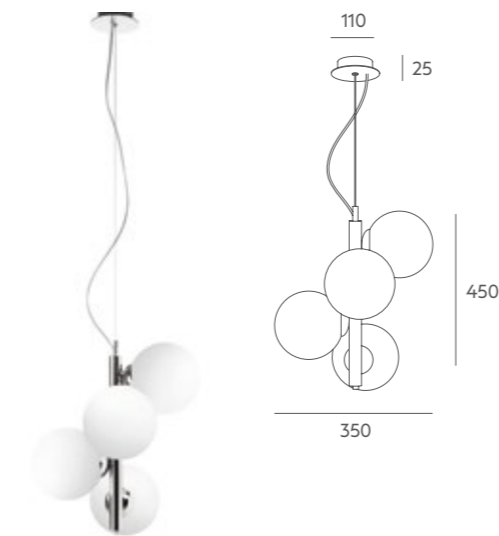

Tecnical data

Frame: painted or coated iron metal.

Details: steel cable + transparent PVC cable. Opal matte clip system glass

Recommended Bulb: E-14 7W LED (not included).

Important: the standard cable length is 1 metre, if you need special size please contact our Customer Support Department. We can value colour changes for projects with a minimum quantity.

Finishes Acabados

Metal Colour / Acabado Metal



Glass / Cristal



Información técnica

Cuerpo: metal hierro pintado o bañado.

Detalles: cable de acero + transparente PVC. Tulipas opal mate cogida con pinzas.

Bombilla recomendada: E-14 7W LED (no incluida).

Importante: la longitud del cable estándar es de 1 metro, si desea una medida especial no dude en ponerse en contacto con nosotros. Se puede valorar cambios de color para proyectos con un mínimo de unidades.



GLASSY

2016 by Massmi

Glassy is reminiscent of the cone-shaped hat worn by traditional Chinese and Japanese farmers. The combination of simple lines with opal glass and wooden accents gives this lamp a discreet and modern feel.

Glassy recuerda a los sombreros que usan los campesinos en China y Japón. La combinación de líneas sencillas, el vidrio opal y los remates en madera de haya le confieren una estética muy discreta y moderna, con cierto sabor entre nórdico y japonés.



MASSMI

SINCE 1942

Suspension lamp
Lámpara de suspensión
Ref 6605 FU

Suspension lamp / Lámpara de suspensión

Ref 6605

LED 1 x 11W **A+**

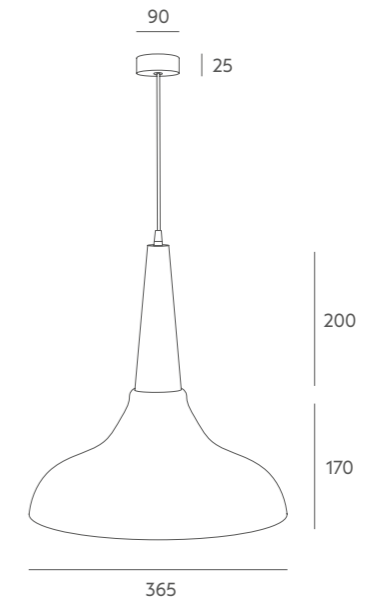

Tecnical data

Frame: beech wood.
 Details: shiny opal or smoked glass. Black textile cable.
 Recommended Bulb: E-27 11W LED (not included).
 Important: the standard cable length is 1 metre, if you need special size please contact our Customer Support Department.

Finishes Acabados

Glass Colour / Acabado Crista



Wood Colour / Acabado Madera



Información técnica

Cuerpo: madera de haya.
 Detalles: cristal opal brillo o fumé. Cable textil negro.
 Bombilla recomendada: E-27 11W LED (no incluida).
 Importante: la longitud del cable estándar es de 1 metro, si desea una medida especial no dude en ponerse en contacto con nosotros.



AURA

2016 by Massmi

Aura has an undeniably sculptural look enhanced by the use of gold or silver leaf on the glass. The glass sphere is cut on the bottom to give off a more nuanced light. This lamp is perfect for creating compositions to add character to a large space, especially when hung in groups with each lamp at a different height. You may not want to switch the lights off ever again!

Aura destaca por un innegable aspecto escultórico acentuado por el uso del pan de oro o de plata sobre vidrio. Un globo de cristal con corte inferior para reflejar una luz llena de matices y efectos lumínicos. Ideal para crear composiciones que realcen una estancia espaciosa y a diferentes alturas para aumentar el efecto de la composición. ¡A partir de ahora no querrás apagar la luz de casa!

MASSMI



Detail silver leaf
Detalle pan de plata

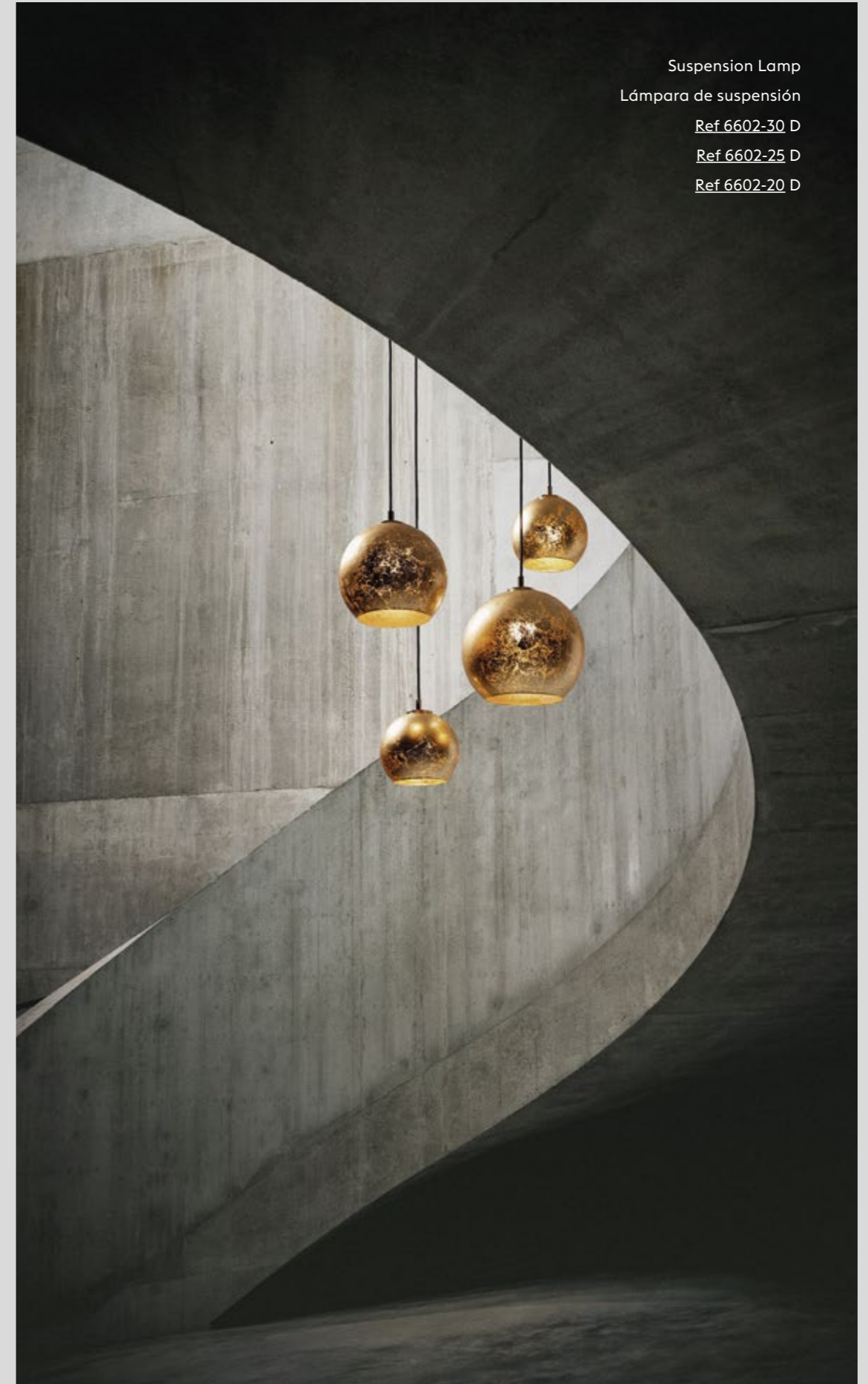

Suspension Lamp
Lámpara de suspensión
Ref 6602-30 D
Ref 6602-25 D
Ref 6602-20 D

SINCE 1942

Suspension lamps / Lámparas de Suspensión

Ref 6602-30

LED 1x11W **A+**

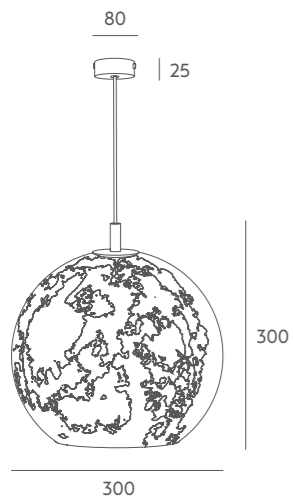

Ref 6602-25

LED 1x11W **A+**

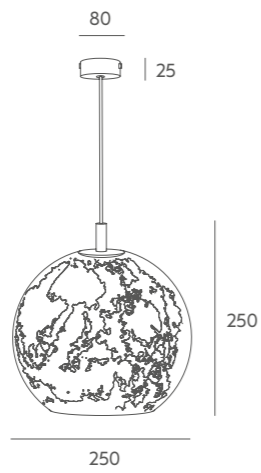

Ref 6602-20

LED 1x11W **A+**

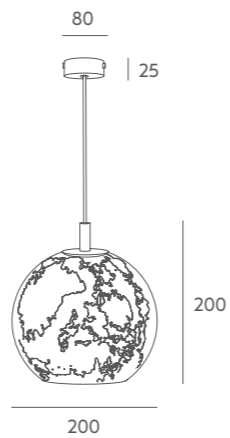

Tecnical data

Frame: chromed or gold iron metal.

Details: decoration with gold or silver leaf. Black textile cable.

Recommended Bulb: E-27 11W (not included).

Important: the standard cable length is 1 metre, if you need special size please contact our Customer Support Department.

Finishes Acabados

Metal Colour / Acabado Metal



CR D

Glass / Cristal



D PL

Información técnica

Cuerpo: metal hierro acabado en cromo u oro brillo.

Detalles: decorado pan de oro o pan de plata. Cable textil color negro.

Bombilla recomendada: E-27 11W (no incluida).

Importante: la longitud del cable estándar es de 1 metro, si desea una medida especial no dude en ponerse en contacto con nosotros.



Suspension lamps
Lámparas de suspensión
Ref 6602-25 D
Ref 6602-30 D

CIRCA

1976 by Massmi

In the Circa collection, the glass provides the mood lighting. Its silhouette and volume lend this flushmount lamp an air of refinement, whether it is installed on the ceiling or the wall. Made of triplex opal glass, Circa lamps give off a subtle, suggestive light. Available in two shapes and three sizes, the Circa collection allows for a great variety of applications and combinations, either in private homes or larger settings, and is perhaps our most versatile collection.

En Circa todo el vidrio se convierte en emisor de luz ambiente. Su perfil y su volumen, nos recuerda que estamos ante un plafón ya sea colocado en techo o en pared de presencia, discreta y refinada. Circa está fabricada en cristal Triplex opalizado y el efecto de luz tamizada es muy sugerente. Sus seis versiones permiten gran variedad de aplicaciones y combinaciones, diseñada para ambientes decorativos, instalaciones y hogares, se trata de un producto muy versátil.



MASSMI

SINCE 1942

Ceiling lamps
Plafones
[Ref 3460-30](#)
[Ref 3460-25](#)
[Ref 3460-20](#)

[Ref 3459-25](#)
[Ref 3459-20](#)

[Ref 3459-30](#)

Ceiling lamps / Plafones

[Ref 3460-30](#)

LED 2 x 7W **A+**

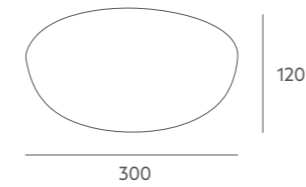

[Ref 3460-25](#)

LED 1 x 7W **A+**



[Ref 3460-20](#)

LED 1 x 7W **A+**

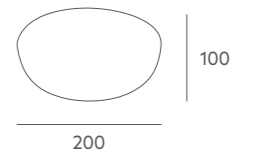

[Ref 3459-30](#)

LED 2 x 7W **A+**

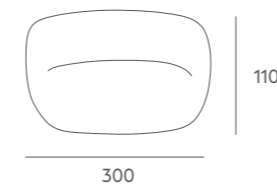

[Ref 3459-25](#)

LED 1 x 7W **A+**

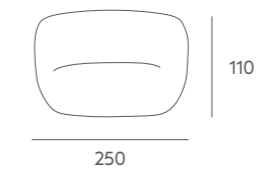

[Ref 3459-20](#)

LED 1 x 7W **A+**

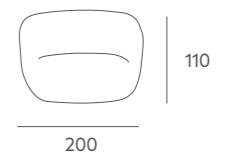

Tecnical data

Frame: zink support

Details: mate opal glass. Stone socket. System to hold the glass by using gyrotory clips.

Recommended Bulb: E-27 7W LED (not included).

Finishes Acabados

Glass / Cristal



OP-MT

Información técnica

Cuerpo: soporte zincado.

Detalles: cristal opal mate. Portalámparas de piedra. Cogida de soporte de cristal mediante pestañas giratorias.

Bombilla recomendada: E-27 7W LED (no incluida).



PURA

2018 by Nacho Timón

Technical and decorative lamp inspired on the Mid Century. Perfect to be used in different kind of spaces offering a perfect general lighting. Very adequate for contract spaces even large areas. It supports bulbs with different powers and projection angles; it's available in two sizes and several colour combinations.

Lámpara técnica a la vez que decorativa cuya esencia se inspira en el Mid Century. Pieza ideal para instalarse en multitud de espacios ofreciendo una perfecta iluminación general. Adecuada en espacios hosteleros, comerciales y grandes superficies. Admite bombillas de varias potencias y ángulos de proyección; y se fabrica en dos tamaños con varias combinaciones de color.



Ceiling lamps
Plafones
[Ref 3422-P BL-D](#) [Ref 3422-G NE-D](#)



Ceiling lamps / Plafones

Ref 3422-P

LED 1 x 15W **A+**

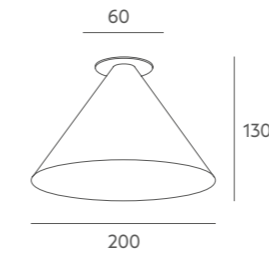

Ref 3422-G

LED 1 x 15W **A+**

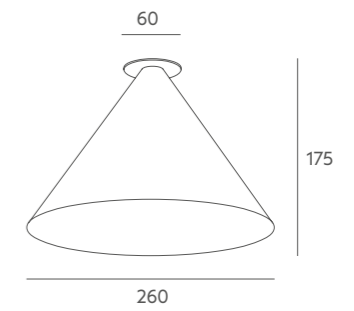

Tecnical data

Frame: painted iron metal in one or two colours.

Details: clip support.

Recommended Bulb: GU10 15W LED. 4000K 1300 Lm 36°. (included)

Important: we can evaluate to change painting colour for projects with a minimum quantity of pieces, please check with us.

Información técnica

Cuerpo: metal hierro pintado monocolor o bicolor.

Detalles: soporte con pinzas, para techos con talla.

Bombilla recomendada: GU10 15W LED. 4000K 1300 Lm 36°. (incluida)

Importante: se puede valorar cambios en la pintura para proyectos con un mínimo de unidades, no duden en consultarnos.

Finishes Acabados

Metal Colour / Acabado Metal

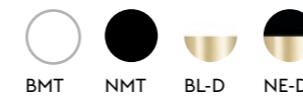

Ref 3422-P BL-D

Ceiling lamps
Plafones
Ref 3422-G NE-D



PETIT

2016 by Massmi

Stylized table lamps, Their small format makes them perfect for creating a warm, cozy nook in any space.

Altas y estilizadas, Pensadas para acompañar en espacios donde queramos aportar un punto de calidez. Se adaptan con facilidad a cualquier espacio.

MASSMI



Color details
Detalles color

Table lamps
Lámparas de pie
[Ref 4434 AZ BL](#)
[Ref 4435 BMT BL](#)
[Ref 4435 TE BL](#)
[Ref 4434 NMT NE](#)
[Ref 4435 NMT NE](#)

Floor lamps
Lámparas de pie
[Ref 5435 BMT BL](#)
[Ref 5435 NMT NE](#)



SINCE 1942

Table lamps / Lámparas de mesa

Ref 4435

LED 1 x 11W **A+**

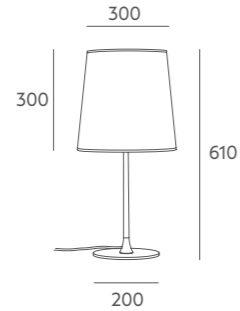

Ref 4434

LED 1 x 11W **A+**

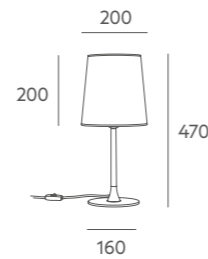

Floor lamp / Lámpara de pie

Ref 5435

LED 1 x 11W **A+**

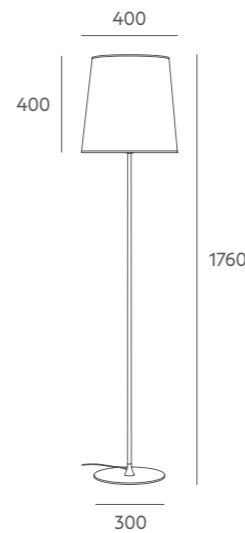

Tecnical data

Frame: painted iron metal.

Details: translucent cotton shade. PVC cable.

Recommended Bulb: E-27 11W LED (not included).

Important: we can value colour changes for projects with a minimum quantity.

Finishes Acabados

Metal Colour / Acabado Metal



Cable / Cable



Shade / Pantalla



Información técnica

Cuerpo: metal hierro pintado.

Detalles: pantalla de tela de algodón traslúcido. Cable PVC.

Bombilla recomendada: E-27 11W LED (no incluida).

Importante: se puede valorar cambios de color para proyectos con un mínimo de unidades.

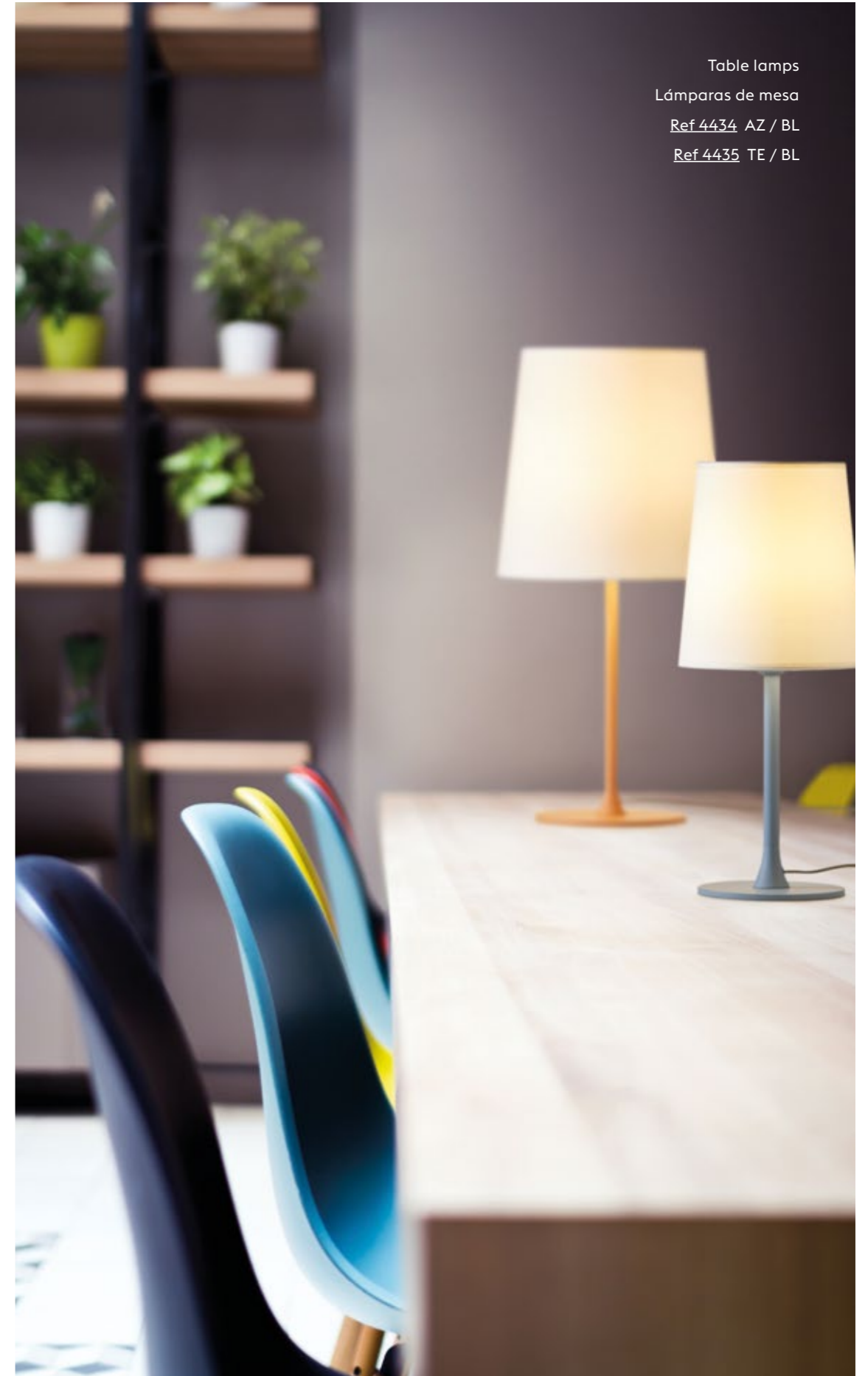

Table lamps
Lámparas de mesa
Ref 4434 AZ / BL
Ref 4435 TE / BL

NAAF

2016 by Massmi

Naaf has a minimal design, a simple cotton shade under a light metal structure. It's perfect to create discreet and comfortable settings. Available in two colors, white and black.

Naaf posee un diseño minimalista, una sencilla pantalla de algodón apoyada sobre una fina estructura metálica. Es perfecta para crear ambientes discretos y confortables. Se presenta en dos colores, blanco o negro.

Project by Alberto García interior design / Proyecto de Alberto García diseño interior



Suspension lamp
Lámpara de suspensión
Ref 6857 BMT BL

Suspension lamp / Lámpara de suspensión

Ref 6857

LED 1 x 11W **A+**



Table lamps / Lámparas de mesa

Ref 4458

LED 1 x 11W **A+**



Tecnical data

Frame: painted iron metal.

Details: translucent cotton shade. PVC cable.

Recommended Bulb: E-27 11W LED (not included).

Important: the standard cable length is 1 metre, if you need special size please contact our Customer Support Department.

Finishes Acabados

Metal Colour / Acabado Metal



Cable / Cable



Shade / Pantalla



Floor lamp / Lámpara de pie

Ref 5457

LED 1 x 11W **A+**



Ref 4457

LED 1 x 11W **A+**



Información técnica

Cuerpo: metal hierro pintado.

Detalles: tela de algodón traslúcido. Cable PVC.

Bombilla recomendada: E-27 11W LED (no incluida).

Importante: la longitud del cable estándar es de 1 metro, si desea una medida especial no dude en ponerse en contacto con nosotros.



QUO

2016 by Massmi

The Quo collection of fixtures was added to our catalogue in 2006 and year after year they have been the best selling lamps from our Basics collection due to their versatility and high quality.

Quo es una de las colecciones que nos acompaña desde el año 2006 y año tras año se posiciona en el ranking de nuestros básicos bestseller, por su versatilidad y alta calidad. Se caracteriza por sus pantallas y formatos cúbicos, un básico que aportará elegancia a cualquier espacio.

Table lamps
Lámparas de mesa
[Ref 4316 AZ BL](#)

[Ref 4315 TE BL](#)

[Ref 4315 NMT NE](#)

[Ref 4316 BMT BL](#)



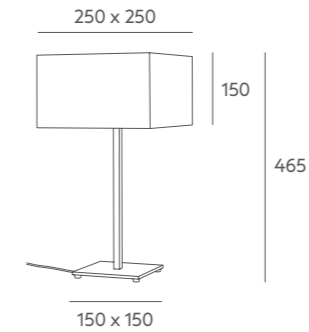

Table lamp
Lámpara de mesa
Ref 4316 AZ BL

Table lamps Lámparas de mesa

Ref 4316

LED 1 x 11W **A+**



Ref 4315

LED 1 x 7W **A+**

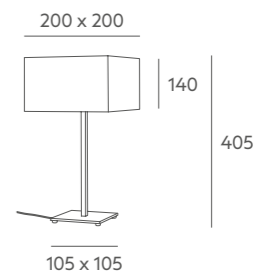

Floor lamp / Lámpara de pie

Ref 5239

LED 1 x 11W **A+**

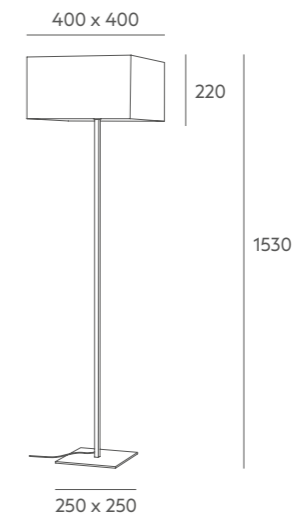

Tecnichal data

Frame: painted iron metal.

Details: translucent cotton shade. PVC cable.

Recommended Bulb: E-27 7W or 11W LED (not included).

Important: we can value colour changes for projects with a minimum quantity.

Finishes Acabados

Metal Colour / Acabado Metal



Shade / Pantalla



Cable / Cable



Información técnica

Cuerpo: metal hierro pintado.

Detalles: pantalla de tela de algodón traslúcido. Cable PVC.

Bombilla recomendada: E-27 7W o 11W LED (no incluida).

Importante: se puede valorar cambios de color para proyectos con un mínimo de unidades.



DLED

2009 by Massmi

Airy, discreet and flexible family of wall lamps to focus light to the desired place (maximum flexion of 90°) without glare. The flex is made of covered iron to guarantee its stability and long life with daily use. Base shapes can be square or round, depending on the particular client's need. Dled is a perfect fixture to use in private or public settings.

Familia de apliques de aspecto ligero, discreto y flexible, lo que permiten focalizar la luz hacia el lugar deseado (flexión máxima 90°) sin producir deslumbramientos. El tubo flexible es de hierro revestido que garantiza su rigidez y una mayor durabilidad. Las bases de este aplique pueden ser de formato cuadrado o redondo según sean las necesidades del usuario. Apto tanto para el ámbito residencial como para el contract.



Wall lamp
Lámpara de pared
Ref 1653 NMT

MASSMI

SINCE 1942

Wall lamps / Lámparas de pared

Ref 1652

LED 1 x 1,4W **A++**

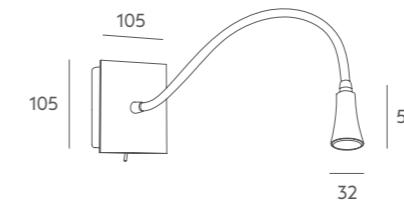

Flexible arm / Brazo flexible 380

Ref 1653

LED 1 x 1,4W **A++**

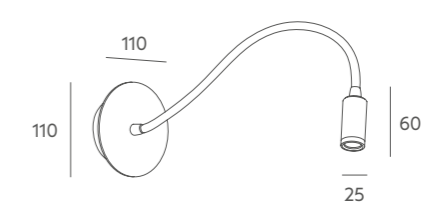

Flexible arm / Brazo flexible 380

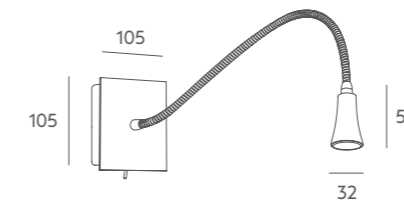

Flexible arm / Brazo flexible 380

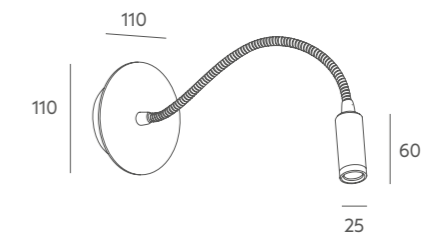

Flexible arm / Brazo flexible 380

Tecnical data

Frame: satin nickel or painted iron metal.

Details: metal switch. Flexible arms.

Recommended Bulb: bulb + transformer included 1,4W LED. 6000K.

Finishes Acabados

Metal Colour / Acabado Metal

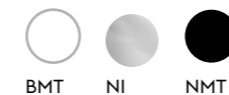

Flexible arm / Brazo flexible

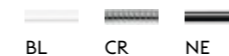

Información técnica

Cuerpo: níquel satinado o metal hierro pintado.

Detalles: interruptor metálico. Brazos flexibles.

Bombilla recomendada: bombilla y transformador incluido: 1,4W LED. 6000K.



DLED SHADE

2009 by Massmi

Extensive collection of wall lamps perfect to use as bedside lamp or in a hall. It includes a cotton lampshade in different shapes combined with the flexible arm. It can be orientable depending on client's need. Available in several colors.

Amplia familia de apliques que se convierte en el aliado perfecto para iluminar de manera focal o ambiental habitaciones y cabeceros de cama, tanto en el ámbito residencial como en el contract. Incluye una pantalla de algodón de formatos varios, que combina con el flexo orientable según necesidades del usuario. Disponible en varios colores.

MASSMI

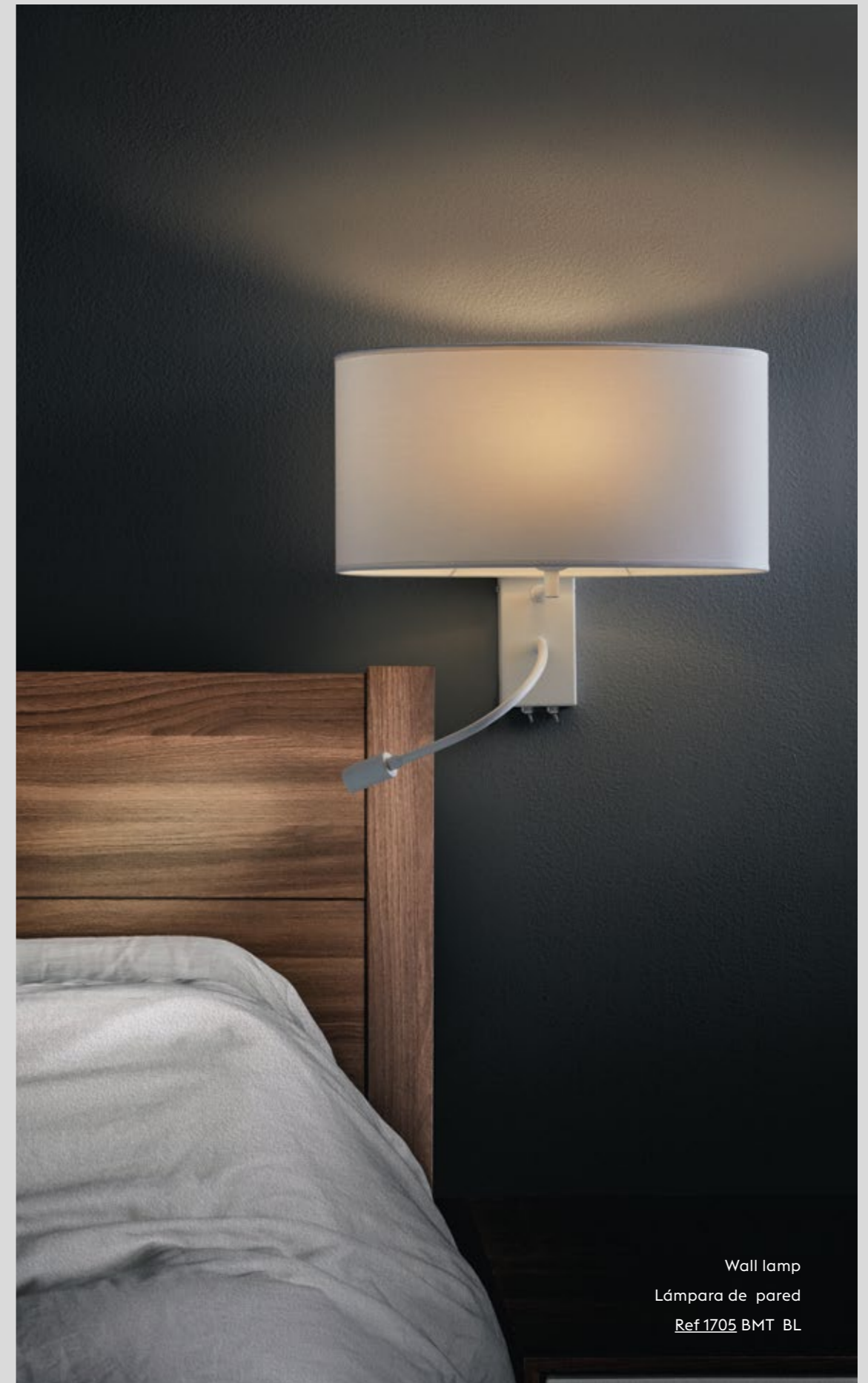

SINCE 1942

Wall lamps / Lámparas de pared

Ref 1705

LED 1x7W · 1x1,4W **A+** **A++**

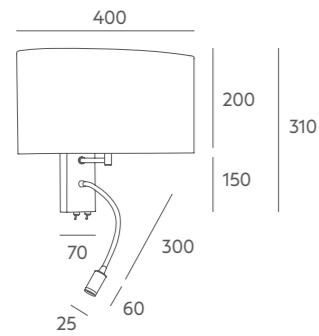

Ref 1706

LED 1x7W · 1x1,4W **A+** **A++**

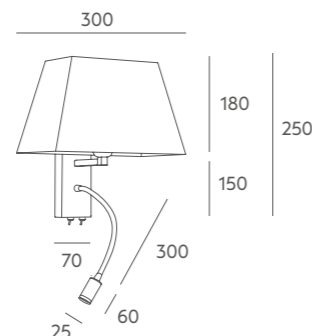

Ref 1698

LED 1x7W · 1x1,4W **A+** **A++**

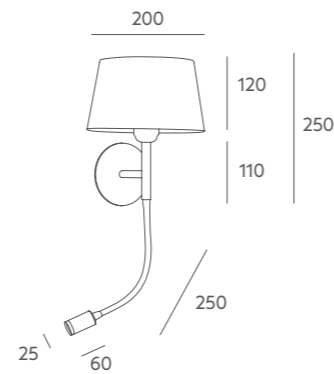

Ref 1664

LED 1x7W · 1x1,4W **A+** **A++**

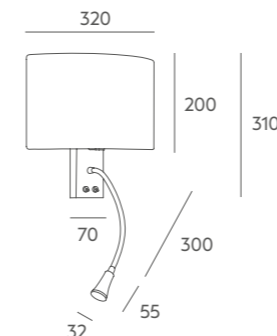

Ref 1663 25 - 30

LED 1x7W · 1x1,4W **A+** **A++**

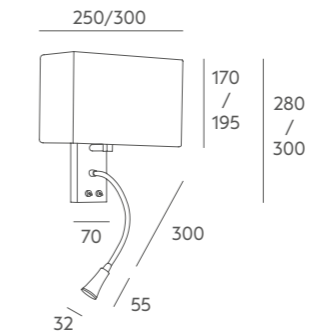

Ref 1651

LED 1x7W · 1x1,4W **A+** **A++**

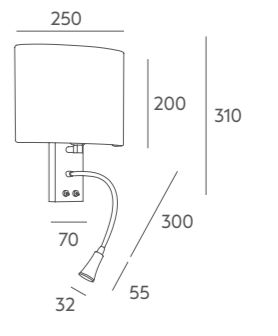

Tecnichal data

Frame: satin nickel or painted metal iron.

Details: cotton shade. Flexible arms.

Recommended Bulb: E-27 7W LED (not included). Arm bulb + transformer included 1,4W LED. 6000K

Important: we can evaluate to change lampshade material for projects with a minimum quantity of pieces, please check with us.

Finishes Acabados

Metal Colour / Acabado Metal

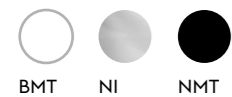

Shade / Pantalla



Flexible arm / Brazo flexible

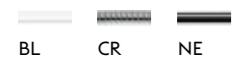

Información técnica

Cuerpo: níquel satinado o metal hierro pintado.

Detalles: pantalla de tela de algodón traslúcido. Brazos flexibles.

Bombilla recomendada: E-27 7W LED (no incluida). Bombilla del brazo y transformador incluido: 1,4W LED. 6000K.

Importante: se puede valorar cambios de tela para proyectos con un mínimo de unidades, no duden en consultarnos.



Tecnichal data

Frame: satin nickel or painted iron metal.

Details: cotton shade. Flexible arms.

Recommended Bulb: E-27 7W LED (not included). Arm bulb + transformer included 1,4W LED. 6000K

Important: we can evaluate to change lampshade material for projects with a minimum quantity of pieces, please check with us.

Finishes Acabados

Metal Colour / Acabado Metal

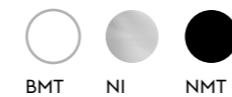

Shade / Pantalla



Flexible arm / Brazo flexible



Información técnica

Cuerpo: níquel satinado o metal hierro pintado.

Detalles: pantalla de tela de algodón traslúcido. Brazos flexibles.

Bombilla recomendada: E-27 7W LED (no incluida). Bombilla del brazo y transformador incluido: 1,4W LED. 6000K.

Importante: se puede valorar cambios de tela para proyectos con un mínimo de unidades, no duden en consultarnos.



SHAPE

2009 by Massmi

Shape is a collection of wall lamps which uses a cotton shade available in different sizes and colors. Despite simplicity it's perfect to create nice ambiances and to light rooms and halls, in both public and private settings.

Shape es una colección de apliques conformados por una pantalla de algodón que se presenta en diferentes tamaños y colores. Pese a su simplicidad, es perfecto para crear agradables ambientes e iluminar pasillos y habitaciones, no sólo en el ámbito residencial, si no que resulta ideal para espacios contract.

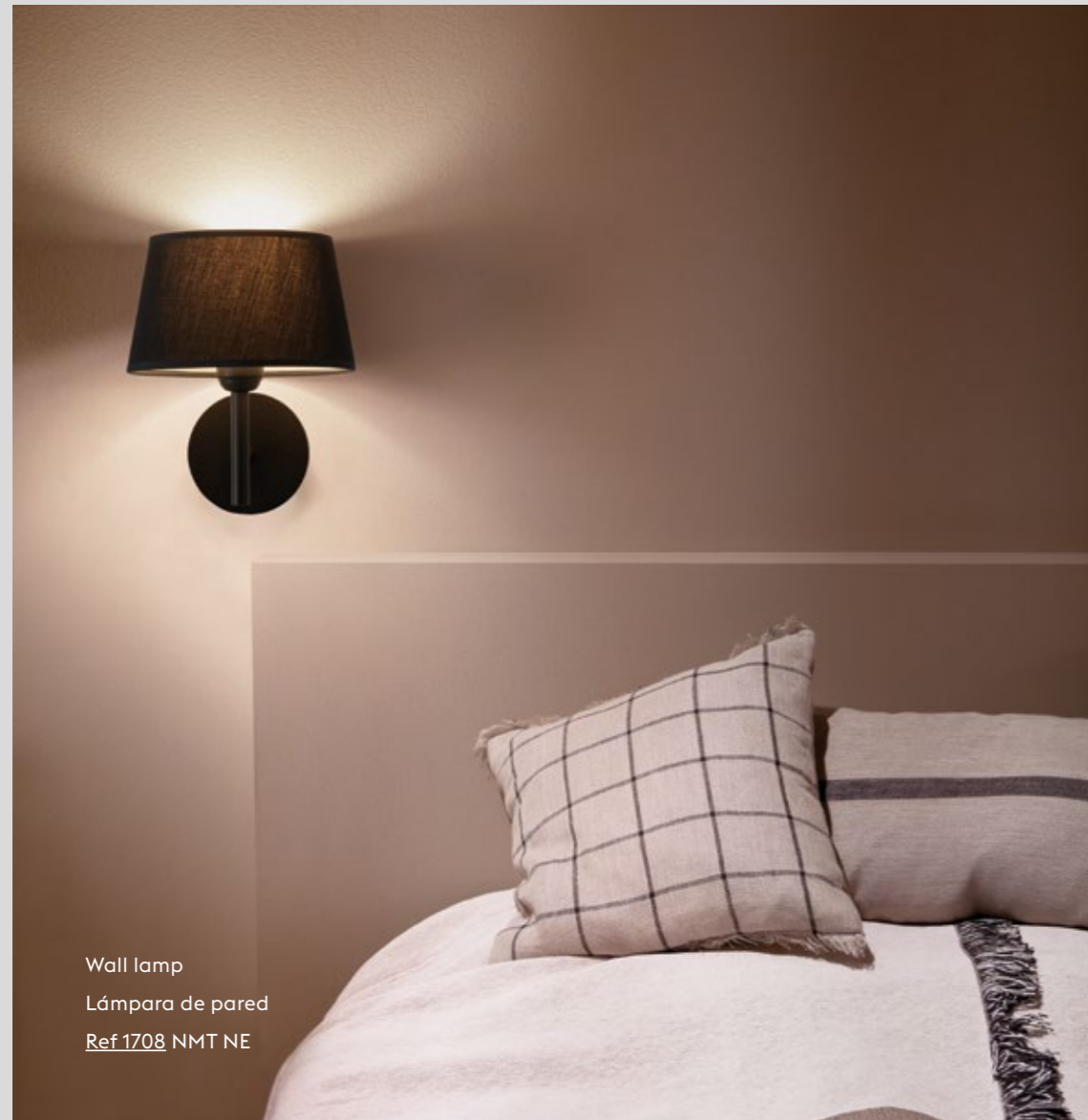

MASSMI

SINCE 1942

Wall lamp
Lámpara de pared
Ref 1708 NMT NE

Wall lamps / Lámparas de pared

Ref 1709

LED 1x7W **A+**

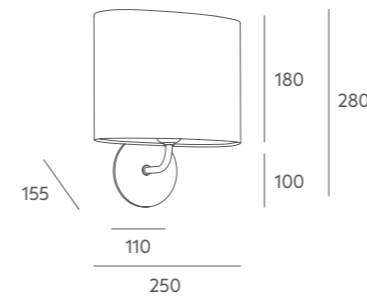

Ref 1708

LED 1x7W **A+**

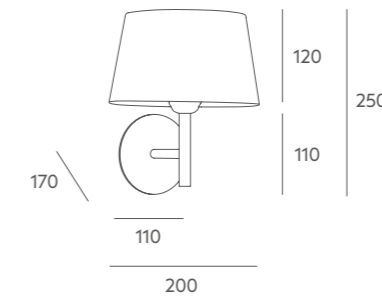

Ref 1703

LED 1x7W **A+**

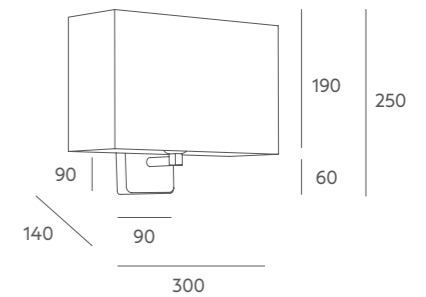

Tecnical data

Frame: satin nickel or painted iron metal.

Details: translucent cotton shade.

Recommended Bulb: E-27 7W LED (not included).

Important: we can evaluate to change lampshade material for projects with a minimum quantity of pieces, please check with us.

Finishes Acabados

Metal Colour / Acabado Metal

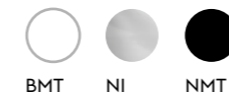

Shade / Pantalla



Información técnica

Cuerpo: níquel satinado o metal hierro pintado.

Detalles: pantalla de tela de algodón traslúcido.

Bombilla recomendada: E-27 7W LED (no incluida).

Importante: se puede valorar cambios de tela para proyectos con un mínimo de unidades, no duden en consultarnos.



SIMPLICITY

2009 by Massmi

Extensive lighting collection of suspensions, ceiling lamps, wall lamps and table lamps, giving the possibility to choose between several sizes, shapes, colors and finishes. Simplicity is a versatile basic piece easy to fit in different kind of ambiances and design styles.

Amplia gama de luminarias que incluye plafones, colgantes, lámparas de pared y sobremesas, ofreciendo la posibilidad de elegir entre múltiples tamaños, formas, colores y acabados. Simplicity es una pieza básica fácil de acomodar en diversos ambientes y estilos por su diseño versátil. Idónea para proyectos de instalaciones que ofrece la posibilidad de jugar con el color y los tamaños, creando así numerosas composiciones.



Suspension Lamp
Lámpara de suspensión
Ref 6920-100 AZ

Suspension lamps / Lámparas de Suspensión

[Ref 6920-100](#) Cotton / Algodón

[Ref 6921-100](#) Pleated / Plisado

LED 5 x 7W **A+**

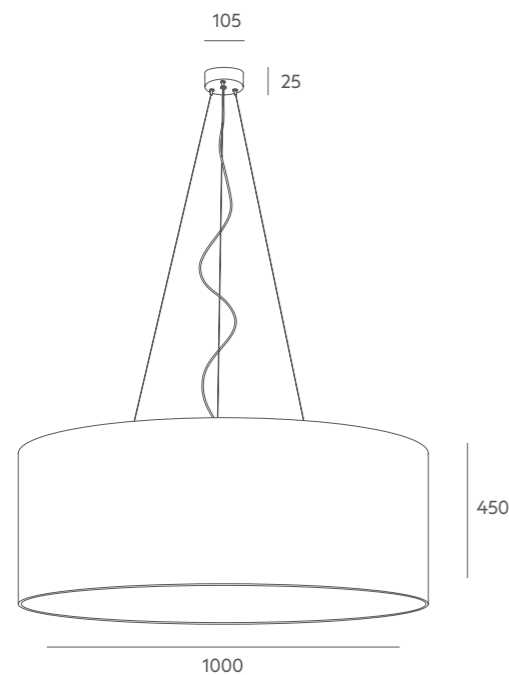

[Ref 6920-60-70](#) Cotton / Algodón

[Ref 6921-60-70](#) Pleated / Plisado

[Ref 6961-60-70](#) Linen / Lino

[Ref 6935-80](#) Lamitex / Lamitex

LED 3 x 11W **A+**

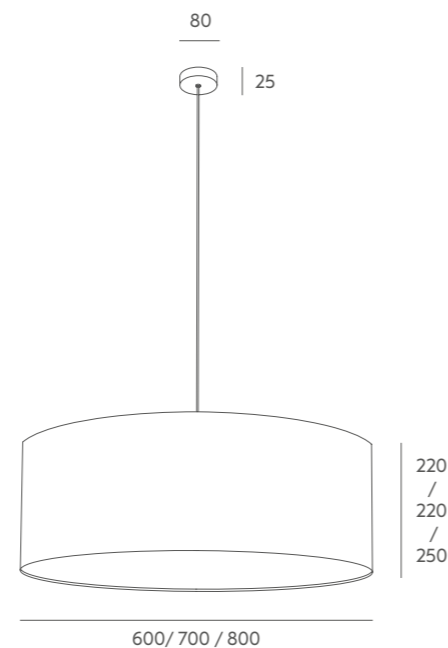

[Ref 6920-50](#) Cotton / Algodón

[Ref 6921-50](#) Pleated / Plisado

[Ref 6961-50](#) Linen / Lino

[Ref 6935-50](#) Lamitex / Lamitex

LED 2 x 11W **A+**



Tecnical data

Details: translucent cotton shade. White parchment diffuser. Black or transparent PVC cable. [Ref 6920-100](#) [Ref 6921-100](#) transparent PVC cable + steel cable and white parchment partial diffuser.

Recommended Bulb: E-27 7W or 11W LED (not included).

Important: the standard cable length is 1 metre, if you need special size please contact our Customer Support Department. We can evaluate to change lampshade material for projects with a minimum quantity of pieces, please check with us.

Finishes Acabados

Metal Colour / Acabado Metal



Cable / Cable

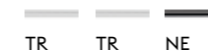

Shade / Pantalla



[Ref 6920-35](#) Cotton / Algodón

[Ref 6921-35](#) Pleated / Plisado

[Ref 6961-35](#) Linen / Lino

[Ref 6935-35](#) Lamitex / Lamitex

LED 1 x 11W **A+**

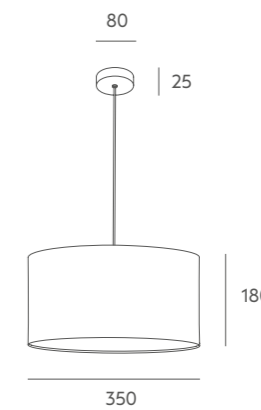

Información técnica

Detalles: pantalla de tela de algodón traslúcido. Difusor de pergamino blanco. Cable PVC negro o transparente. [Ref 6920-100](#) [Ref 6921-100](#) cable transparente + cable de acero y difusor pergamino blanco parcial.

Bombilla recomendada: E-27 7W o 11W LED (no incluida).

Importante: la longitud del cable estándar es de 1 metro, si desea una medida especial no dude en ponerse en contacto con nosotros. Se puede valorar cambios de tela para proyectos con un mínimo de unidades, no duden en consultarnos.



* Metal finish will be as photo, otherwise black metal.

* El acabado del metal será como foto, y en su defecto metal negro.



Suspension Lamp
Lámpara de suspensión
Ref 6921-70 PC NI



Suspension Lamp
Lámpara de suspensión
Ref 6935-80 LA BMT



Ceiling Lamps
Plafones

Ref 3486-40 VE Cotton / Algodón

Ref 3486-60 AZ Cotton / Algodón

Ref 3486-50 MA Cotton / Algodón
Ref 3486-40 VE Cotton / Algodón

Ref 3486-25 x 2 NE Cotton / Algodón

Ref 3486-70 GR Cotton / Algodón



Ceiling lamps / Plafones

Ref 3486-25 Cotton / Algodón

Ref 3465-25 Pleated / Plisado

Ref 3461-25 Linen / Lino

Ref 3490-25 Lamitex / Lamitex

LED 2 x 7W **A+**

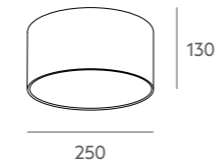

Ref 3486-40 Cotton / Algodón

Ref 3465-40 Pleated / Plisado

Ref 3461-40 Linen / Lino

LED 2 x 11W **A+**

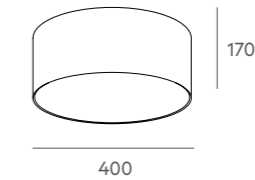

Ref 3486-50 Cotton / Algodón

Ref 3465-50 Pleated / Plisado

Ref 3461-50 Linen / Lino

LED 2 x 11W **A+**

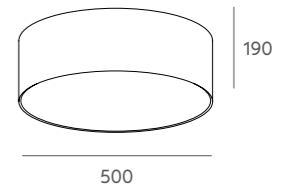

Ref 3486-60 Cotton / Algodón

Ref 3465-60 Pleated / Plisado

Ref 3461-60 Linen / Lino

LED 4 x 11W **A+**

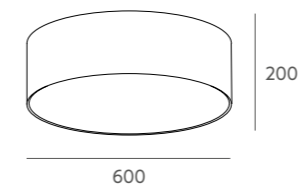

Ref 3486-70 Cotton / Algodón

Ref 3465-70 Pleated / Plisado

Ref 3461-70 Linen / Lino

LED 4 x 11W **A+**

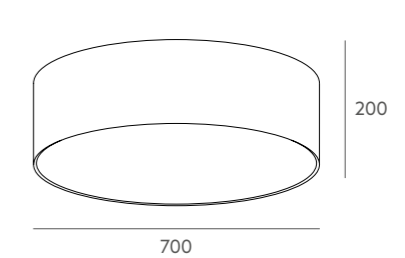

Tecnical data

Details: Opaque cotton lampshade. White parchment diffuser. Stone socket. Magnet system.

Recommended Bulb: E-27 7W or 11W LED (not included).

Important: we can evaluate to change lampshade material for projects with a minimum quantity of pieces, please check with us.

Finishes Acabados

Shade / Pantalla



Información técnica

Detalles: pantalla de tela de algodón traslúcido. Difusor de pergamino blanco. Portalámparas de piedra. Sistema de sujeción de la pantalla con imanes.

Bombilla recomendada: E-27 7W o 11W LED (no incluida).

Importante: se puede valorar cambios de tela para proyectos con un mínimo de unidades, no duden en consultarnos.





Ceiling lamps
Plafones
Ref 3470 BL
Ref 3466-40 MA

Ceiling lamps / Plafones

Ref 3489-50 Cotton / Algodón

Ref 3490-50 Lamitex / Lamitex

LED 2 x 11W **A+**



Ref 3489-60-70 Cotton / Algodón

Ref 3490-60-70 Lamitex / Lamitex

LED 4 x 11W **A+**

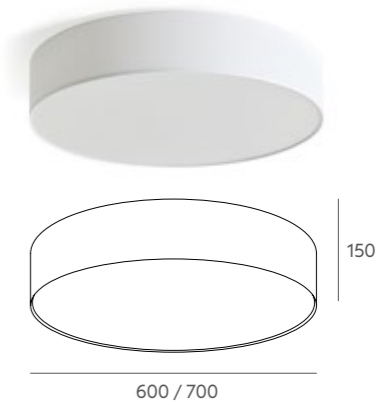

Ceiling lamps / Plafones

Ref 3466-35-40-50 Cotton / Algodón

35-40 LED 2 x 11W **A+**

50 LED 4 x 11W **A+**

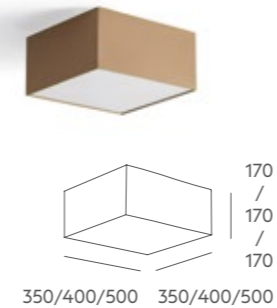

Ref 3469 Cotton / Algodón

LED 2 x 11W **A+**

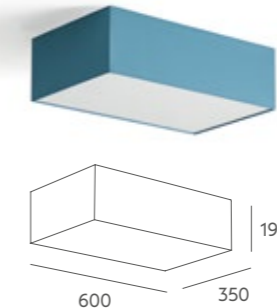

Ref 3470 Cotton / Algodón

LED 4 x 11W **A+**

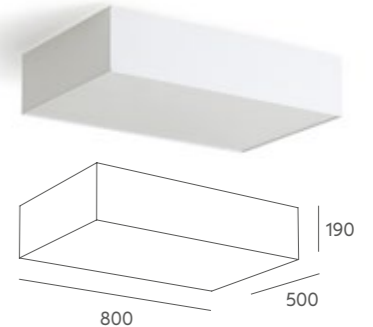

Tecnical data

Details: pleated or not cotton shade. Ref 3489 Ref 3490 cotton or lamitex shade shorter height. White parchment diffuser. With stone sockets and magnet system to hang the shade.

Recommended bulb: E-27 11W LED (not included).

Important: we can evaluate to change lampshade material for projects with a minimum quantity of pieces, please check with us.

Finishes Acabados

Shade / Pantalla Ref 3489 Ref 3490



Shade / Pantalla Ref 3466 Ref 3469 Ref 3470



Información técnica

Detalles: pantalla tela algodón liso o plisado traslúcido. Ref 3489 Ref 3490 pantalla tela algodón o lamitex y altura reducida. Difusor de pergamino blanco. Portalámparas de piedra y sistema de sujeción de la pantalla con imanes.

Bombilla recomendada: E-27 11W LED (no incluida).

Importante: se puede valorar cambios de tela para proyectos con un mínimo de unidades, no duden en consultarnos.



Wall lamps / Lámparas de pared

Ref 1674 Cotton / Algodón

Ref 1673 Pleated / Plisado

Ref 1676 Linen / Lino

Ref 1675 Lamitex / Lamitex

LED 1 x 7W  

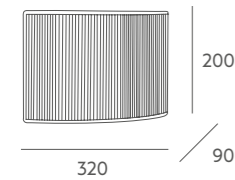

Ref 1656 Cotton / Algodón

Ref 1655 Pleated / Plisado

Ref 1657 Linen / Lino

LED 1 x 7W  

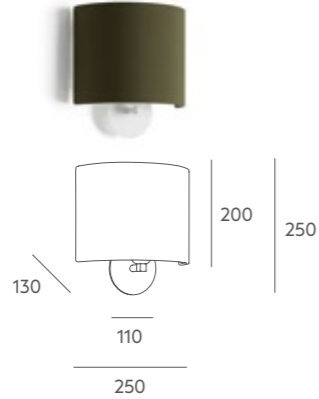

Ref 1654-25-30 Cotton / Algodón

LED 1 x 7W  

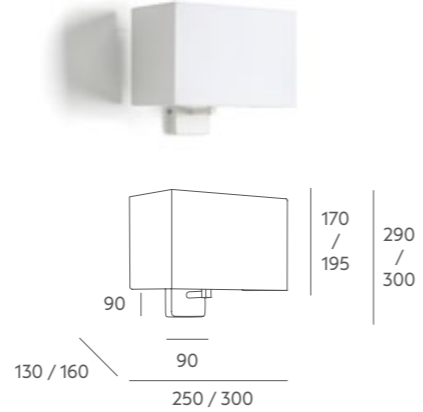
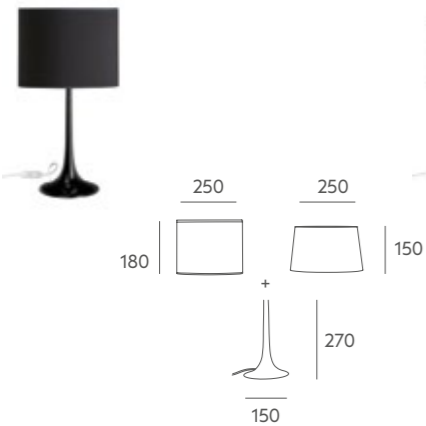

Table lamps / Lámparas de mesa

Ref 4364

LED 1 x 7W  



Ref 4365

LED 1 x 7W  

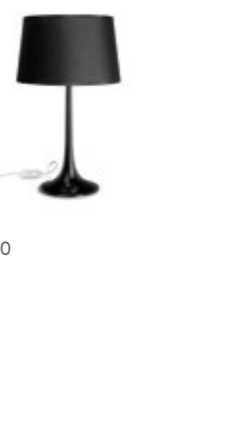

Ref 4366

LED 1 x 7W  

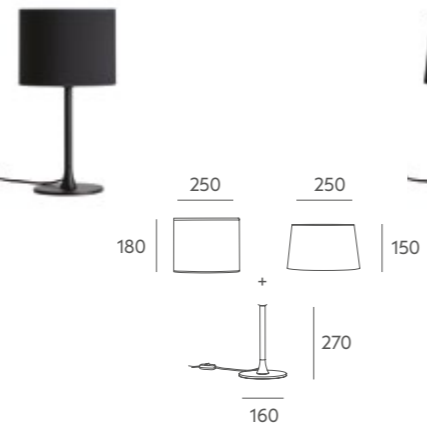

Ref 4367

LED 1 x 7W  

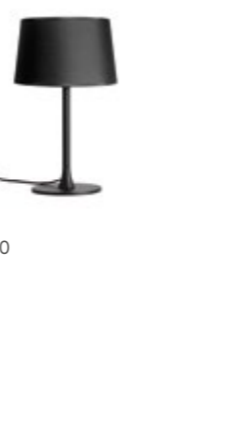

Tecnichal data

Details: painted or coated iron metal. Traslucet cotton shade. Black or transparent PVC cable according to version.

Recommended Bulb: E-27 7W LED (not included).

Important: we can evaluate to change lampshade material for projects with a minimum quantity of pieces, please check with us.

Información técnica

Detalles: metal hierro pintado o bañado. Pantalla de tela de algodón traslúcido. Cable PVC negro o transparente según versión.

Bombilla recomendada: E-27 7W LED (no incluida).

Importante: se puede valorar cambios de tela para proyectos con un mínimo de unidades, no duden en consultarnos.

Finishes Acabados

Metal Colour / Acabado Metal



BMT NI NMT

Cable / Cable



TR TR NE

Shade / Pantalla



AZ BL CR GR MA NE LA LI-BL LI-MA PC VE



LINEAR COMBINATIONS COMBINACIONES LINEALES

Complete your project using linear bars in different sizes for our lighting fixtures.

Completa tus proyectos usando las regletas lineales en sus distintos tamaños en nuestras luminarias.

G435-80

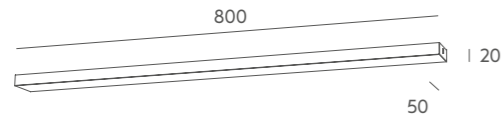

G435-50

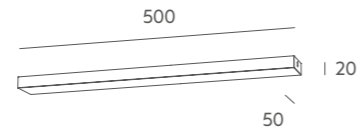

G435-30

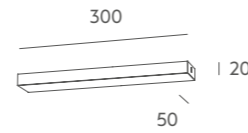

Metal Colour / Acabado Metal



BMT NMT

Example composition / Ejemplo composición

G435-50 + Ref 6984 + Ref 6985

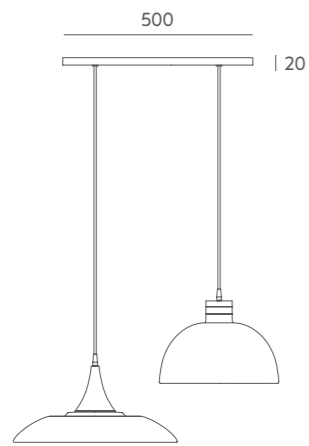

G435-50 + Ref 6992 x 2 + Ref 6991 x 2

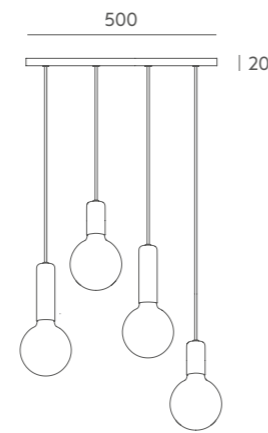

G435-50 + Ref 6012 G x 2

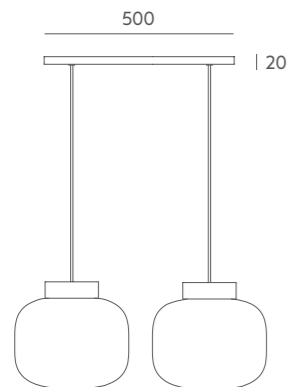

G435-30 + Ref 6012 P + Ref 6012 G

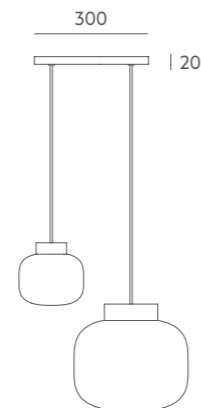

G435-80 + Ref 6015-60 x 2

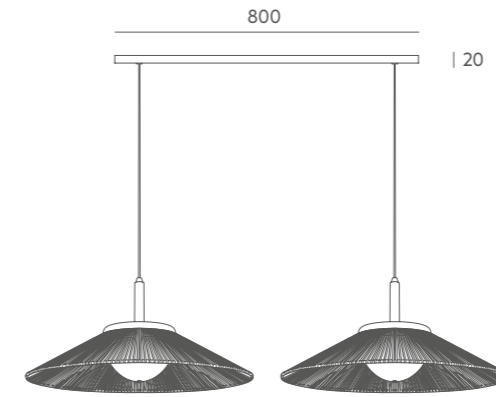

G435-80 + Ref 6018 x 2 + Ref 6017

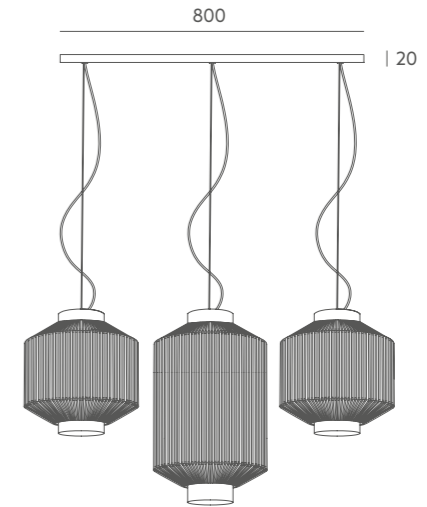

G435-80 + Ref 6974 + Ref 6982 + Ref 6976 + Ref 6973

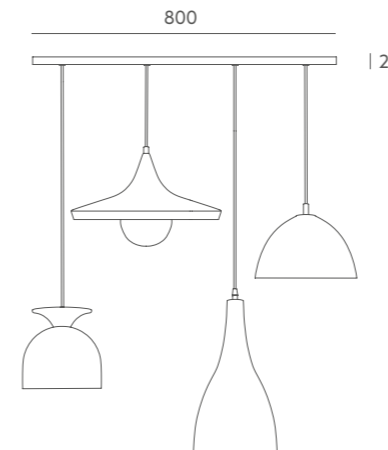

G435-80 + Ref 6983 G x 2 + Ref 6983 P x 2

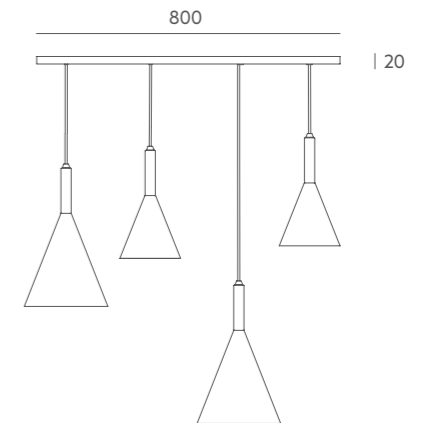

G435-80 + Ref 6921-35 x 2 Pleated / Plisado

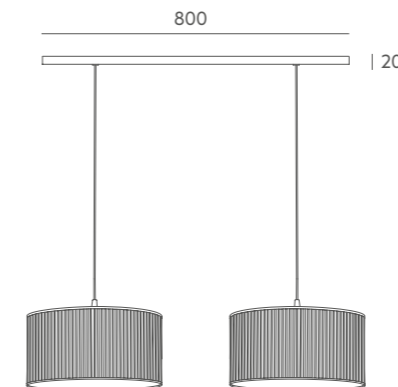

G435-80 + Ref 6920-50 x 2 Cotton / Algodón

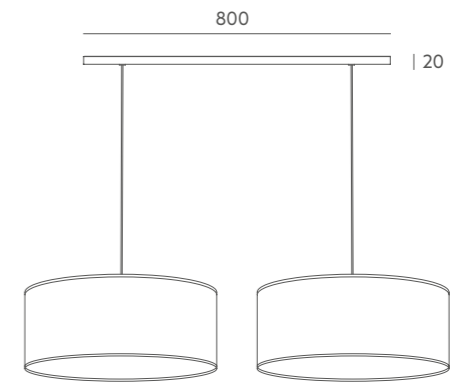

ROUND COMBINATIONS COMBINACIONES CIRCULARES

Complete your projects using round plates in different sizes to personalize our lighting fixtures.

Completa tus proyectos con los platos circulares en sus distintos diámetros para personalizar nuestras luminarias.

G434-70

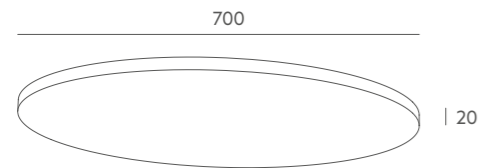

G434-45

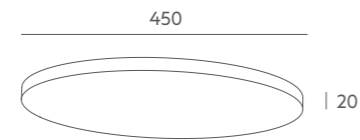

G434-30

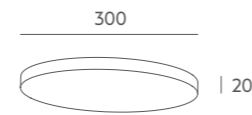

Metal Colour / Acabado Metal



BMT NMT

Example composition / Ejemplo composición

G434-70 + Ref 6013-1 x 3 + Ref 6013-2 x 2

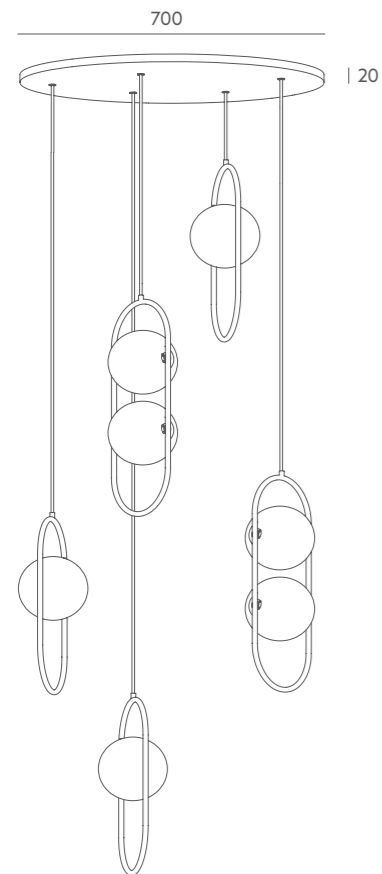

G434-70 + Ref 6015-40 x 3 + Ref 6015-60 x 2



G434-45 + Ref 6002 x 3 + Ref 6001 x 2

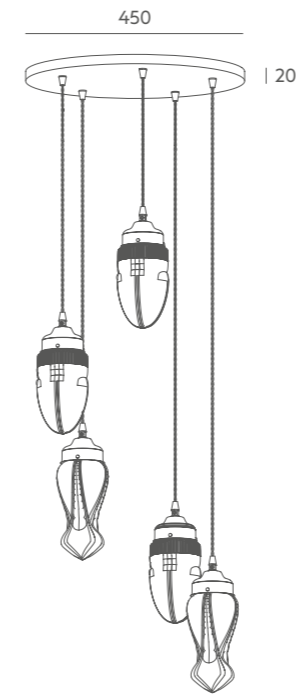

G434-45 + Ref 6984 x 2 + Ref 6985

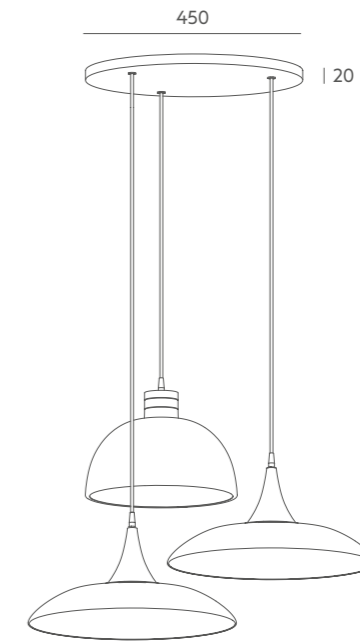

G434-30 + Ref 6983 P x 2 + Ref 6983 G

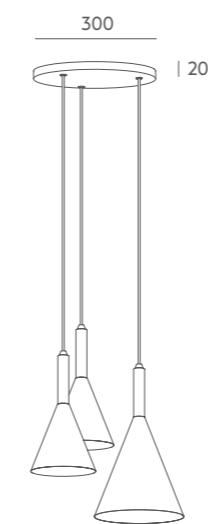

G434-30 + Ref 6013-1 + Ref 6013-2

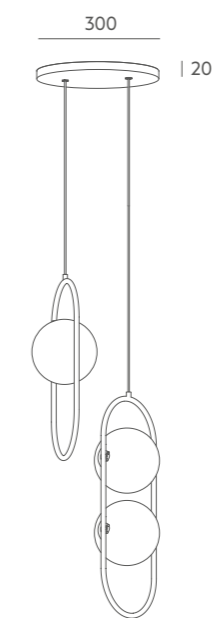

G434-30 + Ref 6992 x 2 + Ref 6991

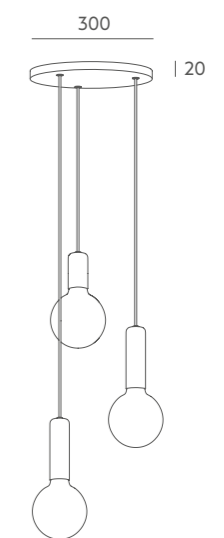

BULBS BOMBILLAS

Complete your lighting fixtures with this bulb selection.

Completa tus luminarias con esta selección de bombillas.

Ref 03083 PL
E27 6W LED (750 lm) **A+**
2.700° K / 25.000h



Ref 03083 CO
E27 6W LED (750 lm) **A+**
2.700° K / 25.000h



Ref 03080
E27 6W LED (750 lm) **A+**
2.700° K / 25.000h



Ref 03081
E27 40W **A+**
Decorative incandescent / 1.000h



Ref 03094-125
E27 6W LED (800 lm) **A+**
2.700° K / 25.000h



Ref 03078
E27 4W LED (180 lm) **A+**
2.700° K / 25.000h



Ref 03076
E27 4W LED (500 lm) **A+**
3.000° K / 25.000h



Ref 03077
E27 4W LED (500 lm) **A+**
3.000° K / 25.000h



Ref 03082
G9 4W LED (350 lm) **A+**
3.000° K / 25.000h



Ref 03086
E27 11W LED (1.100 lm) **A+**
3.000° K / 25.000h



Ref 03084
E27 7W LED (650 lm) **A+**
3.000° K / 25.000h



Ref 03085
E14 7W LED (650 lm) **A+**
3.000° K / 25.000h



SCROLLINGS DESPLAZAMIENTOS

These small pieces will give shape to your installation and allow you to run your cables exactly in the way you imagined.

Estas pequeñas piezas darán forma a tu instalación y te permitirán desplazar los cables de la forma que imagines.

Decentralizer, ceiling hook for textile electric cable.
Descentralizador, gancho de techo para cable eléctrico textil con tope.

Ref 03036 NE



Decentralizer, ceiling or wall V hook for textile electric cable.
Descentralizador, gancho en V de techo o pared para cable eléctrico textil.

Ref 03037 NE



Universal cablefitting to fix textile cable to the Wall.
Prensaestopas universal para fijación a la pared para cable textil.

Ref 03038 NE



Ref 03036 BL



Ref 03037 BL



Ref 03038 BL



GENERAL SPECIFICATIONS

CARACTERÍSTICAS GENERALES

COMMENTS

The products of the Massmi brand owned by Industrias Massmi S.L. are designed and manufactured to keep customers satisfied, so we inform them of:

- 1 Due to the quality of our finishes, we recommend using a soft dry polish cloth for cleaning, avoiding the use of special cleaning products that could damage the finish.
- 2 Do not use lamps of a higher power than indicated.
- 3 All models are patent protected.
- 4 Measurements in mm.
- 5 Standard cable length 1 m.
- 6 The lampshades included in this catalogue are our standard shades, made in Spain. Can be delivered as spare part. You can ask for changes of material for a minimum of 4 pieces.
- 7 Massmi will attend all the Customer claims within 7 days after the goods reception.
- 8 Massmi will not accept any claim concerning damages produced by the transport agency if the Customer does not inform the agency within a maximum of 24 hours after delivery.
- 9 Devolutions of material accepted by Massmi need to have the original packing. For claims concerning shades it is necessary to keep it in same plastic packaging, we won't accept any claim without it.

Industrias Massmi S.L. reserves the right to modify or discontinue, without previous notice, products in the catalog.

OBSERVACIONES

Los productos de la marca Massmi propiedad de Industrias Massmi S.L. han sido diseñados y fabricados para satisfacer al máximo a nuestros clientes, por eso les informamos de:

- 1 Dada la calidad de nuestros acabados, aconsejamos efectuar la limpieza exclusivamente con una gamuza seca, evitando el uso de productos especiales que podrían dañar la superficie.
- 2 No deberán utilizarse bombillas de potencia superior a la indicada.
- 3 Modelos protegidos por el Registro de la Propiedad Industrial.
- 4 Medidas en mm.
- 5 Cable largo estándar 1 m.
- 6 Las pantallas que aparecen en catálogo son nuestras pantallas estándar todas ellas de fabricación nacional. Podrán ser suministradas sueltas. A partir de 4 unidades se pueden solicitar cambios de material (siempre que sea posible dicho cambio).
- 7 Massmi atenderá todas las reclamaciones efectuadas dentro de los 7 días hábiles posteriores a la recepción de la mercancía y con la hoja de gestión de los pedidos que enviamos junto al albarán debidamente cumplimentada.
- 8 Massmi no se hará cargo de roturas o deterioros producidos por la agencia de transporte si el cliente no lo ha comunicado a la agencia dentro de un plazo máximo de 24h desde la recepción de la mercancía.
- 9 Las devoluciones de material aceptadas por Massmi tendrán que venir siempre en su embalaje original. Para efectuar reclamaciones de pantallas será imprescindible que el artículo sea devuelto con la protección original (plástico retráctil), no se aceptarán aquellos que no lo lleven.

Industrias Massmi S.L. se reserva el derecho a modificar o anular, sin previo aviso, productos de este catálogo.

SYMBOLS / SÍMBOLOS



Products manufactured according to the European safety and electromagnetic standards (EN 60598-1 and EN 60598-2-1)
Productos fabricados acorde con las directivas de seguridad y emisiones electromagnéticas según la legislación europea aplicable (EN 60598-1 y EN 60598-2-1)



Product protected against the penetration of solid bodies equal or bigger than 12 mm and against the access with a finger. No protection to the water (standard NF C 20 010)
Producto protegido contra la penetración de cuerpos sólidos de diámetro superior o igual a 12mm. No accesible con los dedos. Sin protección al agua (norma NF C 20 010)



Basic insulation with earth wire (products Class I)
Aislamiento básico con toma de tierra (productos de Clase I)



Reinforced or double insulation, without earth wire (products Class II)
Aislamiento reforzado o doble, sin toma de tierra (productos de Clase II)



Energy efficiency / Low consumption / -30%
Eficiencia energética / Bajo consumo / -30%





Energy efficiency / Low consumption / 30%-42%
Eficiencia energética / Bajo consumo / 30%-42%

FINISHES

ACABADOS













ROPE COLOUR / ACABADO CUERDA

-  MA Brown rope / Cuerda Marron
-  TE Terracotta rope / Cuerda terracota
-  VE Green rope / Cuerda verde

























METAL PLATE FINISHES / ACABADOS BAÑO

-  CO Shiny copper / Cobre brillo
-  CR Chrome / Cromo
-  D Shiny gold / Dorado brillo
-  GR Graphite / Grafito
-  D Satin gold / Dorado satinado
-  CO Satin copper / Cobre satinado
-  DM Gold matte / Dorado matte
-  LA Satin brass / Latón satinado
-  NI Nickel satin / Niquel satinado

PAINTED FINISHES / ACABADOS PINTURA

-  AZ Blue / Azul
-  BMT Matte white / Blanco mate
-  D Gold paint / Pintura oro
-  GR Grey / Gris
-  GR Graphite / Grafito
-  NMT Matte Black / Negro mate
-  CO Copper paint / Pintura cobre
-  TE Terracotta / Terracota
-  VE Green / Verde
-  BL-D Matte white (ins D) / Blanco mate (int D)
-  NE-D Matte black (ins D) / Negro mate (int D)
-  NMT-D Matte black with gold kneecup / Negro mate con rótula latonada
-  VE-D Matte green with gold kneecup / Verde mate con rótula latonada









SHADE MATERIALS / PANTALLAS

-  AZ Blue cotton / Algodón Azul
-  BL White cotton / Algodón blanco
-  CR Beige / Algodón crema
-  GR Grey cotton / Algodón gris
-  NE Black cotton / Algodón negro
-  MA Brown cotton / Algodón Marrón
-  VE Green cotton / Algodón verde
-  BL-D White cotton (ins D) / Algodón blanco (int D)
-  CR-D Beige cotton (ins D) / Algodón Crema (int D)
-  D-CR Gold (ins CR) / Dorado (int CR)
-  NE-D Black cotton (ins D) / Algodón negro (int D)
-  BL Ash-tree white colored / Fresno tintado blanco
-  HA Natural beech / Haya natural
-  LI-BL White linen / Lino blanco
-  LI-MA Brown linen / Lino marron
-  RE Reed weaved / Rejilla
-  BL Ribbon of white silk / Cinta seda blanca
-  CR Ribbon of cream silk / Cinta seda crema
-  GR Ribbon of grey silk / Cinta seda gris
-  NE Ribbon of black silk / Cinta seda negra
-  VE Ribbon of green silk / Cinta seda verde
-  LA Lamitex / Lamitex
-  PC Beige pleated / Plisado crema
-  PLI Pleated parchment / Pergamino plisado
-  PN Black pleated / Plisado negro





FINISHES

ACABADOS

GLASS / CRISTAL

-  AM Amber glass / Cristal ambar
-  AZ Blue glass / Cristal azul
-  D Gold / Pan de oro
-  PL Silver / Pan de plata
-  MT Matte / Mate
-  TR Transparent / Transparente
-  FU Smoked / Fume
-  OP Shine Opal / Opal brillo
-  OP-MT Opal matte / Opal mate

WOOD / MADERA

-  HA Natural beech / Haya natural
-  HA-NE Black beech / Haya negra
-  RO Oak / Roble
-  BL Lacquered white / Blanco lacado

METHACRYLATE / METACRILATO

-  OP Opale / Opal

LEATHER / PIEL

-  MA Brown leather / Piel marrón

STONE / PIEDRA

-  MA Black marble / Mármol Negro

INTERIORISME

i s m o b l e

MOBILIARI

DES DEL 1981

ISMOBLE ES UNA TIENDA DE MUEBLES DE DISEÑO Y DE INTERIORISMO.

Somos una tienda de muebles y complementos de diseño moderno con un estilo diferente, realizamos proyectos de interiorismo a la medida de cada espacio y para cada persona.

Con una experiencia de más de 40 años.



c. dionís puig, 15
el ramassar
08402 granollers
barcelona

t. 93 840 29 18
shop@ismoble.com



www.ismoble.com

/// TIENDA ONLINE //////////////////////////////////////